

Pricelist

April 2024 NL/BE incl. VAT

Informatie

- p.3 **Important information**
- p.5 **Materials**
- p.15 **Maintenance instruction**
- p.19 **Warranty**

Tables

- p.25 **Table overview**
- p.26 **Balance**
- p.30 **Base**
- p.34 **Cast**
- p.38 **Dew**
- p.40 **Essential**
- p.44 **Essenza**
- p.52 **Extend**
- p.56 **Grid**
- p.64 **HAT**
- p.66 **Joist**
- p.70 **Kami**
- p.78 **Move**
- p.82 **Shift**
- p.86 **Slim**
- p.92 **Slim+**
- p.98 **Spazio**
- p.102 **Trestle**
- p.107 **Cable Management**

Seating & Low seating

- p.129 **Information**
- p.130 **Arc**
- p.30 **Base Bench**
- p.132 **Bock**
- p.134 **Close**
- p.140 **Ease**
- p.44 **Essenza Bench**
- p.142 **Frame**
- p.142 **Frame Friendly**
- p.146 **Home-Work**
- p.148 **Laze**
- p.150 **Re-volve**
- p.152 **Side by Side**
- p.156 **Sketch Office**
- p.162 **Sketch Regular**
- p.86 **Slim Bench**
- p.92 **Slim+ Bench**

Low tables & Flexible objects

- p.168 **Bow**
- p.170 **Dew Coffee Table**
- p.172 **Pivot**
- p.174 **Tablet**
- p.176 **Tre**
- p.178 **Utensil**

Pricelist

April 2024 NL/BE incl. VAT

Important information

Website

All up to date product information (images, 2d/3d data, maintenance instructions, material options, list of fabrics, and so on) can be found on www.arco.nl.

Standard and tailoring

Standard product dimensions and tailoring options are listed on each fact-sheet. Wishes (specials) beyond this will be evaluated after application and will be granted only under certain conditions. Each fact sheet indicates what the standard sizes of a product are and, if so, within which frameworks tailoring is possible. Versions that fall outside this framework will be assessed after application and only granted if they are part of a large order (> €50,000), or if other weighty interests apply.

Ordering guide

The ordering guide shows the choices that need to be made when ordering a product.

Matrix

If the price matrix does not include a price for a material or size, this version is technically not possible.

Order confirmation

The confirmation will be sent by e-mail within a week after receipt of an order. Should this not be the case, please report this, so that the order will not be delayed.

It is important to check the order confirmation carefully.

In addition to the order confirmation, you will receive a sales drawing of each product ordered with the confirmed dimensions of the furniture. Please note that a tolerance applies to the stated dimensions. This deviation applies to tables, chairs and small furniture.

Order modification/cancellation

It is important to properly carefully check the order confirmation. It is possible to cancel within 7 days (5 working days) after the order has been sent by email to change or cancel the order.

After the expiration of this period the confirmation is binding and changes in the order are no longer possible.

Delivery time

Arco produces on request. Our delivery time can vary and is dependent on the type of order, the capacity and the availability of the required materials.

Planned delivery week

On the order confirmation we mention our planned delivery week. This week is subject to approval of our final quality check.

COM

It is possible to upholster your furniture in COM. This is always upon request and, if necessary, after approval of a fabric sample submitted by you.

It is not possible to upholster your furniture in your own leather.

Orders will be processed after receiving the sended COM on the following address:

Arco Meubelfabriek B.V.
Parallelweg 2-III
NL-7102 DE Winterswijk

On the packaging, your company name with the order number and/or commission name must be clearly stated. Different commissions should not be delivered together in one package.

Veneer table legs

In addition to P- (project) lacquer or N- (natural matt) lacquer, solid wood and duramas can also be finished with oil. Veneer can only be finished with lacquer.

This means that, for tables with a solid wood or duramas top, but a veneer base, you can choose an oil finish for the top but must specify a lacquer finish for the base (this applies specifically to Balance, Essential, HAT, Kami, Spazio and Extend).

Wooden bases for seating

The wooden bases of our seating furniture are only available in N- or P-lacquer finish.

Smoked oak

A smoked oak table top always comes with a 1300 oak black frame. There are two exceptions: Base and Joist. They do come with a smoked oak frame. Duramas smoked oak is not available with an oil finish.

Brushing

Brushing is optional for solid and duramas table tops with a lacquer finish with a maximum width of 128 cm.

Wheels/footcaps

The frames are standard provided with footcaps for both hard floors and carpets. The castors are suitable for all types of flooring.

Sales conditions

All our agreements are subject to the general sales conditions of the Central Union of Furniture manufacturers, registered at the Court of Amsterdam, dated March 16th 2018 under number 9/2018. A copy is available on request.

Small order surcharge

For orders with a net invoice value less than € 750,- we charge € 25,- net.

It is not possible to combine orders afterwards. If you want to save on small order surcharge, you have to submit combined orders yourself.

Materials

Please note that the printed samples only serve as indication of the color.

Wood

Wood is a natural material and no two trees are the same. Each piece of furniture is a natural reflection of the specific wood it is made from and has its own unique wood grain. Therefore, despite our careful selection, there may be variations in texture or colour. Please allow for localised light or dark discolouration, which often only becomes apparent after processing.

It is important for wood to maintain its moisture content. To prevent the wood from 'moving' (shrinking or expanding), we recommend keeping the relative humidity in the room as constant as possible (around 60%). The temperature should also be kept as constant as possible.

Wood discolours under the influence of (sun)light and takes on its final colour after a few months. In the case of extendable tables, the inserts should therefore also be exposed to light during these months. They can then be stored (if they are separate inserts) or retracted (integrated inserts).

As wood discolours when exposed to (sun)light and takes on its final colour after a few months, re-ordered furniture will never have the same colour.

Solid wood (Arco premium quality)

Our solid wooden table tops are composed of solid wooden strips of varying widths which are glued together. The tables can be finished with mat-natural finish (hereafter N-finish), project finish (hereafter P-finish) or with oil. Natural characteristics of the wood such as knots, deformations, black spots etc. are inevitable. With premium quality solid wood, open defects must never be visible, (however, they may for instance be found on the underside of the table top). Solid wood is extremely sensitive to fluctuations in temperature and humidity, which could cause the wood to "work" and create e.g. little cracks in the course of time.

Solid wood (Local Wood)

Local Wood is wood from the region around the Arco factory in Winterswijk. Local Wood does not hide any 'imperfections' in the wood. Knots are often part of the table top and give it its own character. These knots are never open, they are closed.

Duramas (semi-solid wood)

Duramas is composed of a thin layer of premium quality solid wood, which is glued onto the top and bottom of a supporting core panel (e.g. poplar), which provides for an extremely stable sandwich construction. The advantage of Duramas is that high quality wood is sparingly used, while the top layer is still strong enough to be sanded and oiled like solid wood. Duramas is sensitive to fluctuations in temperature and humidity which could cause the wood to "work" and create little cracks in the course of time.

Veneer

Veneer is a thin layer of wood glued onto a core panel. The advantage of veneer is that it is real wood, with the corresponding warm appearance and tactility, but it hardly 'works' (shrinking and expansion). Arco uses a special method where the veneer sheets are mirrored so that the patterns in the wood optically continue, thereby creating an even wood image.

Finishes

Stain colors

Our oak furniture (including solid wood, duramas and veneer) can be stained in different colors. Staining is a technique where the color is applied to the wood while the wood structure remains clearly visible. Stained wood can be finished with N-finish or P-finish. Finishing with oil is not possible.

Smoked oak

Oak contains tannin, the same substance that makes red wine and black tea 'dry'. This substance reacts to the ammonia vapours that are dispersed in the drying chamber during the drying process. Due to this the wood colors "through and through". The tannin concentration determines the color, which may vary from light brown, to a warm deepbrown and sometimes almost black. This concentration is influenced by the soil composition and the living environment of the tree and can therefore differ greatly per trunk and even among different sections of the same trunk. Even though the color is selected during the production process, it is impossible to guarantee that everything will stay in the same color. In other words, color differences always occur in smoked oak.

Furthermore, we would like to inform that the smoked oak we use for our tables is no premium quality solid oak. For that reason natural characteristics such as little knots or black spots, deformations, etc. might be visible. Smoked oak can be finished with N- or P-lacquer and oil (only solid).

Brushed oak (only on solid wood)

Brushing creates a relief between softer and harder growth rings. The depth is influenced by the wood's natural properties: the density, flat or quarter sawn and the structure. There will always be variations in 'depth' and 'coarseness'. The grooves will be deeper in the 'softer' wood parts. Cracks cannot be avoided and will hence remain visible. The table top can become somewhat uneven due to the brushing, thereby creating a risk of splinters. When a product from our Local Wood collection will be brushed, whitish spots, knots, differences in color and all other natural properties of 'Local Wood' will remain visible. Brushed oak can be finished with an N- or P-lacquer.

Oil finish for solid wood and duramas

Oiled solid wooden and duramas tables show the natural radiance of the wood even better than solid wooden tables with N- or P-finish. Tables with an oil finish are somewhat more sensitive to stains and moisture however, and therefore require some maintenance. Arco solid wooden and duramas tables are treated with a high quality oil, which is only made from ecologically responsible materials. The oil nourishes and protects the wood.

Lacquer finishes for veneer, solid wood, duramas and color lacquer

We only use finishings which meet the highest quality standards. You can choose from two different finishes: N- or P-finish. The two different finishes provide excellent protection for the wood.

N-finish gives the wood an unmistakable mat appearance.

P-finish gives the wood a slight gloss. The P-finish is less sensitive to forming stains, and is therefore easier to maintain than N-finish.

Lacquer colors

A wide range of our furniture can be lacquered in various colors, whereby the color is applied on the material. Lacquer colors are not possible for solid wooden and duramas tables.

In addition to the standard P-lacquer finish, N-lacquer is also available for dark colours.

Laminates

HPL Fenix® NTM

Nano technology is used for FENIX® NTM surfaces. The surface is obtained through the next generation of resins, developed by Arpa Industriale. With this technology, FENIX NTM® has access to advanced features such as an extremely mat surface which is soft to touch, protects against fingerprints and provides thermal recovery from minor scratches. This innovative material also has specific properties that facilitate cleaning and no special maintenance is required. FENIX® NTM is resistant to fungus, has improved anti-bacterial properties and is resistant to rubbing, scratching and abrasion.

Forbo Furniture Linoleum

Furniture Linoleum is a bio-based, natural material produced in the Netherlands. Furniture Linoleum does not leave fingerprints, is antistatic and has a pleasant writing surface.

The material is 'alive', develops a patina with use (just like leather) and has a number of associated characteristics. These include small marks, dents or shiny streaks.

Metals

Aluminum

Aluminium is a material that is easy to cast, which means that an aluminium base can be moulded and finished into the desired shape. Aluminium requires little maintenance, it provides a great shape freedom and it is a lightweight material.

Artisanal cast aluminum

For the production of the base of the Joist and Trestle, Arco has chosen for a artisanal cast base (sand casting and Coquille casting). In this production method, aluminum is scooped from a crucible in a molten state and then poured into a mold (made of sand or metal).

Due to the rapid solidification in the mold, a fine-grained structure is formed, similar to the texture of an orange peel. Characteristic of this technique is the presence of small visible holes on the surface. It is also possible for shallow streaks or small bumps to occur on the surface. These characteristics are inherent to this casting process.

Finish: Epoxy fine texture

Epoxy is a thermo-hardening plastic material which adheres to virtually any surface. Epoxy is also abrasion resistant and requires little maintenance. Applying epoxy to metal provides a very durable surface treatment and offers a wide range of colors. We have various epoxy colors available in our collection.

Finish: Mat chrome

Chrome is a resistant surface material that resists scratches well. In case of a base in chrome, a layer of chrome is applied to metal.

Finish: Aluminum

We have aluminium basis available both in brushed and polished versions. Optically, brushed aluminium provides the product with a softer look than polished aluminium.

Concrete

Concrete is composed of the binding agent cement, mixed with water and aggregates such as gravel and sand. By combining the correct amounts, a stone-like and durable material is created which can be shaped as required through a casting process. Concrete has a robust appearance and it is an ideal material for creating a stable table.

Textile

Our seating furniture is available in many fabrics from different manufacturers, but we closely collaborate with Kvadrat (<http://kvadrat.dk>), De Ploeg (www.deploeg.com), Gabriel (www.gabriel.dk/en/) en Camira (www.camirafabrics.com).

For the complete and current fabric list visit www.arco.nl/en/downloads

Leather

Leather groups b and d

Aniline leather is provided with a protective layer, but is not completely covered. With this method of finishing, the natural properties of the leather are retained as much as possible. In use, the leather will obtain its own character, which is mainly determined by the typical gloss (patina) that leather obtains after a period of time.

Semi-aniline and dyed leather

These types of leather are not only colored, but they also have a topcoat that partially covers the natural properties. This type of finishing creates a user-friendly surface.

For the current leather collection visit our website: www.arco.nl/en/downloads

oak: neutrals (solid, semi-solid, veneer)



oak: colors (solid, semi-solid, veneer)

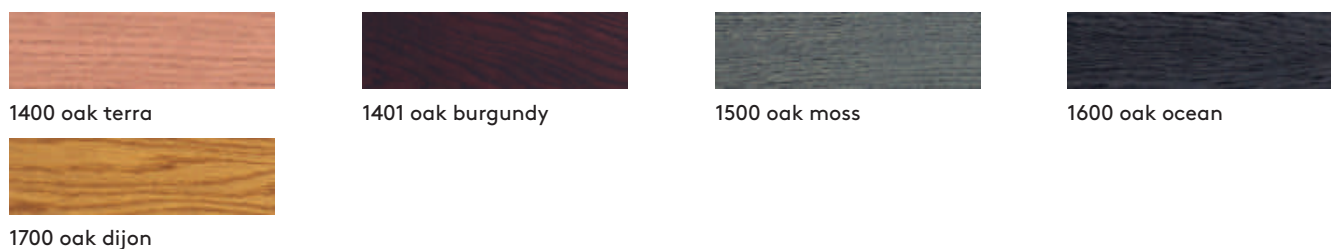

oak: neutrals (solid, semi-solid)



oak: smoked (solid, semi-solid)

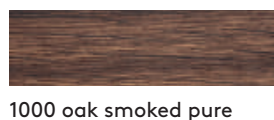









walnut (solid, semi-solid, veneer)



















wood finish (solid, semi-solid)



color lacquer: neutrals

			
5100 white (GN.02.88/RAL9010)	5101 beige (F2.05.65)	5200 grey (FN.02.77)	5201 quartz grey (F7.05.37/RAL7039)
			
5202 mud (F2.10.50)	5203 silt (F2.10.40)	5301 black (UN.00.07/RAL 9005)	5703 Deep Brown (C2.04.06/RL8022)

color lacquer: yellow, green, red, blue color groups

			
5400 clay (C8.20.40)	5401 red (C4.60.30)	5402 burnt red (C4.35.15)	5403 wine red (B1.16.12/RAL3007)
			
5500 mute green (H8.07.47)	5501 emerald green (L0.20.40)	5502 moss green (G0.20.30)	5503 deep green (J5.16.15/RAL6007)
			
5600 slate blue (P0.03.55)	5601 petrol blue (R0.30.30)	5602 prussian blue (T0.10.30)	5603 deep blue (U1.11.08/RAL5004)
			
5700 lime (G0.55.80)	5701 ochre (E8.50.50)	5702 mustard (E4.30.40)	5703 deep brown (C2.04.06/RAL8022)

epoxy fine texture: neutrals

			
5100 white (RAL9010)	5200 grey (FN.02.77)	5201 quartz grey (RAL7039)	5204 grey beige (RAL1019)
			
5300 black grey (RAL7021)	5301 black (RAL9005)		

epoxy fine texture: colors

			
5400 clay (C8.20.40)	5403 wine red (RAL3007)	5404 rust (custom Arco color)	5503 deep green (RAL6007)
			
5600 slate blue (RAL7042)	5603 deep blue (RAL5004)	5604 ultramarine (RAL5002)	5702 mustard (E4.30.40)
			
5703 deep brown (RAL8022)			

Please note that the printed samples only serve as indication of the color.

concrete

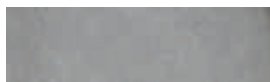

Natural

metal



Mat chrome



Aluminum



Stainless steel

laminates: Fenix



7100 Bianco Male (0029)



7101 Bianco Kos (0032)



7102 Bianco Alaska (0030)



7200 Grigio Londra (0718)



7201 Grigio Antrim (0752)



7202 Beige Arizona (0748)



7203 Grigio Efeso (0725)



7204 Beige Luxor (0719)



7300 Nero Ingo (0720)



7301 Grigio Aragona (0793)



7400 Viola Orissa (0790)



7401 Rosso Jaipur (0751)



7402 Rosso Namib (0789)



7403 Rosso Askja (0770)



7500 Verde Comodoro (0750)



7501 Verde Brac (0773)



7502 Verde Kitami (0794)



7600 Blu Fes (0754)



7601 Blu Shaba (0792)



7602 Azzurro Naxos (0771)



7603 Grigio Bromo (0724)



7700 Cacao Orinoco (0749)



7701 Castoro Ottawa (0717)



7702 Giallo Evora (0791)

laminates: Forbo Furniture Linoleum

			
8101 Pearl (4157)	8301 Pebble (4175)	8302 Mushroom (4176)	8303 Vapour (4177)
			
8304 Ash (4132)	8305 Pewter (4155)	8306 Iron (4178)	8307 Charcoal (4166)
			
8308 Nero (4023)	8401 Powder (4185)	8402 Clay (4001)	8403 Salsa (4164)
			
8405 Burgundy (4154)	8406 Mauve (4172)	8407 Orange Blast (4186)	8501 Spring Green (4182)
			
8502 Pistachio (4183)	8503 Olive (4184)	8504 Conifer (4174)	8506 Aquavert (4180)
			
8601 Midnight Blue (4181)	8602 Smokey Blue (4179)	8701 Leather (4002)	8702 Walnut (4003)

There may be slight colour variations from sample to sample and product to product. Furniture linoleum has certain characteristics that customers should be aware of. Arco cannot be held responsible for these inherent material characteristics. Therefore, Arco cannot accept any complaints in this respect.

Er kunnen lichte kleurvariaties zijn van monster tot monster en van product tot product. Furniture Linoleum heeft bepaalde kenmerken waarvan klanten zich bewust moeten zijn. Arco kan niet verantwoordelijk worden gehouden voor deze intrinsieke materiaal kenmerken. Klachten die hierop betrekking hebben kan Arco derhalve niet accepteren.

Von Muster zu Muster und von Produkt zu Produkt sind leichte Farbabweichungen möglich. Furniture Linoleum verfügt über bestimmte Merkmale, über die der Kunde informiert sein sollte. Arco übernimmt keine Verantwortung für diese Materialeigenschaften und diesbezügliche Beschwerden.

leather

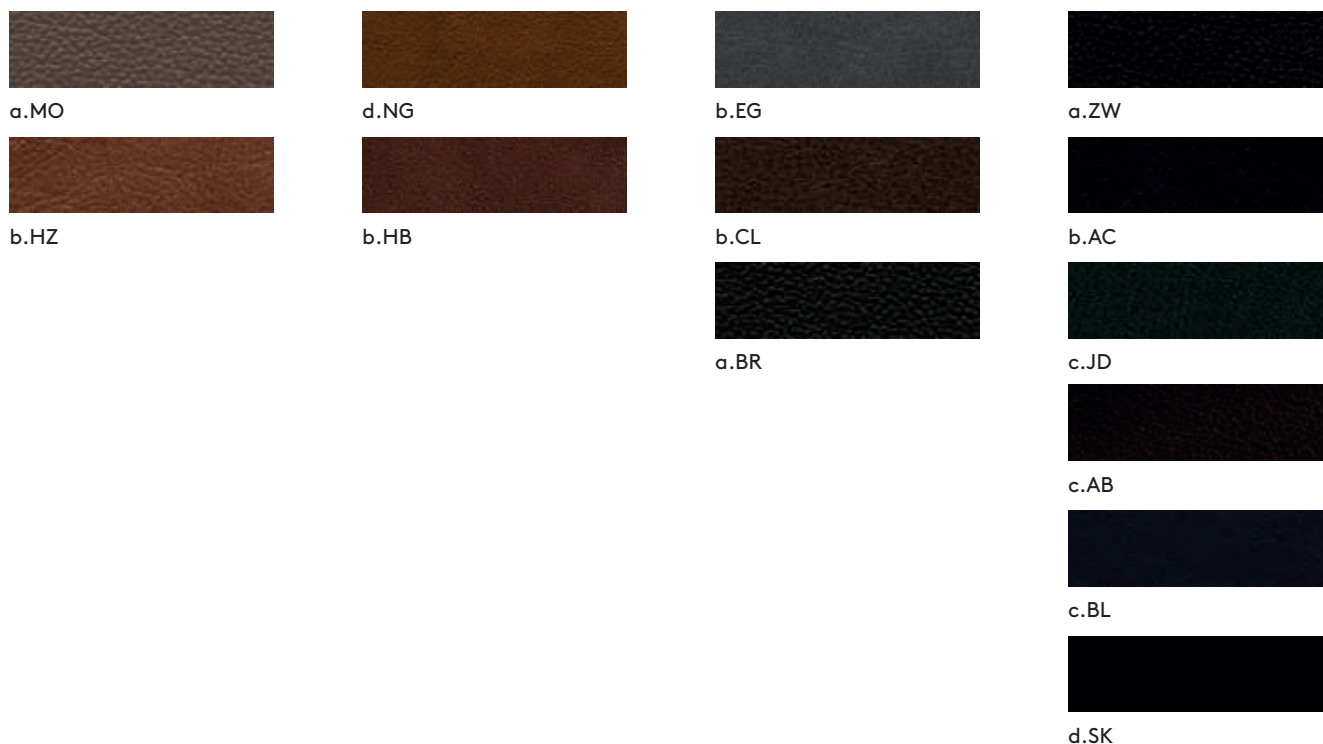

Our seating furniture is available in our own leather collection. We also work with the following collections from Ohmann (www.ohmannleather.com) 1012 (leather group C), 1010 (leather group D) and for the Close, Laze and Re-volve also with Elmosoft (leather group D). Ohmann leather is possible with the purchase of at least 4 chairs or 1 bench in the same version.

Onze stoelen en banken zijn leverbaar in onze eigen leercollectie, maar wij werken ook met de volgende collecties van Ohmann (www.ohmannleather.com) 1012 (leergroep C), 1010 (leergroep D) en voor de Close, Laze en Re-volve ook met Elmosoft (leergroep D). Ohmann leer kan bij afname van tenminste 4 stoelen/1 bank) in dezelfde uitvoering.

Unsere Sitzmöbel sind in unserer eigenen Lederkollektion lieferbar. Wir arbeiten auch mit den folgenden Kollektionen von Ohmann (www.ohmannleather.com) 1012 (Ledergruppe C), 1010 (Ledergruppe D) und bei Close, Laze und Re-volve auch mit Elmosoft (Ledergruppe D). Ohmann-Leder ist möglich bei einer Bestellung von mindestens 4 Stühlen oder 1 Bank in der gleichen Ausführung.

textile

Our seating furniture is available in many fabrics from different manufacturers. Among others, we work with with Kvadrat (<http://kvadrat.dk>), De Ploeg (www.deploeg.com), Gabriel (www.gabriel.dk/en/) en Camira (www.camirafabrics.com). The fabric group classification can be found in the fabric list at www.arco.com/downloads

Onze stoelen en banken zijn leverbaar in vele stoffen van verschillende fabrikanten. Wij werken onder andere met Kvadrat (<http://kvadrat.dk>), De Ploeg (www.deploeg.com), Gabriel (www.gabriel.dk/en/) en Camira (www.camirafabrics.com). De stofgroep indeling is te vinden in de stoffenlijst op www.arco.nl/downloads

Unsere Sitzmöbel sind in zahlreichen Stoffen von verschiedenen Herstellern lieferbar. Wir arbeiten unter anderem mit Kvadrat (<http://kvadrat.dk>), De Ploeg (<http://www.deploeg.com>), Gabriel (www.gabriel.dk/en/) und Camira (www.camirafabrics.com). Die Klassifizierung der Stoffgruppen finden Sie in der Stoffliste auf www.arco.nl/downloads

Maintenance instructions & Warranty

General

Before using, we recommend you to clean your furniture with a damp cloth (for example with ZO Alles Schoon from the maintenance kit delivered with the table) to remove any remaining dust residues. It is recommended to also clean the underside of the legs. Make sure that the carpet is completely dry before placing the furniture on a cleaned carpet.

Hard (scratches!), hot (shrinkage!) or wet (stains!) objects must never be placed directly on the table, as it could cause irremovable damage. It is therefore recommended to always use coasters.

Some of our products have removable parts; should there arise some space in the joints as a result of dryness or use, simply tighten the bolts and screws of the construction.

We also like to point out to you again the fact that wood is a natural material. For example, the final colour of the wood develops under the influence of (sun)light during use (ask your dealer for explanation and advice). For an equal colouring, it is advisable to also place the extra leaves in the same light during the first months. Very important for the condition of the wood is to maintain the humidity of the air as constant as possible (approx. 60%) in order to avoid drying out of the wood (shrinkage!).

Wood

Wood (veneer, solid, duramas) with P-lacquer and furniture with colour lacquer

Daily cleaning with a cotton cloth. Remove stains with a damp cloth or with ZO Alles Schoon from maintenance kit delivered with the table. More persistent stains can be removed using ZO Keuken Schoon. This is degreasing kitchen cleaner which can be ordered on www.zoschoon.nl.

When the cleaning agent can soak for a while you will get the best result. You can spray in the table and wipe away with the delivered cloth. Always clean the table thoroughly with clean water to remove the detergent used (however, do not over-wet the surface). Finally, dry the table top thoroughly. Always work in the direction of the grain. Never use wax, wax-containing substances or abrasive agents.

Wood (veneer, solid, duramas) with mat-natural finish (N-finish)

Daily cleaning with a cotton cloth. Important: N-finish is more sensitive to grease than P-finish. This finish therefore requires a little more attention as to daily maintenance. Remove grease stains immediately with a moist cloth or with ZO Alles Schoon from the delivered maintenance kit delivered with the table. More persistent stains can be removed using ZO Keuken Schoon. This is a degreasing kitchen cleaner which can be ordered on www.zoschoon.nl.

When the cleaning agent can soak for a while you will get the best result. You can spray in the table and wipe away with the delivered cloth. Always clean the table thoroughly with clean water to remove the detergent used (however, do not over-wet the surface). Finally, dry the table top thoroughly.

Important: liquids spilled on the surface should be cleaned up immediately or within 5 to 10 minutes at most! Pollen (e.g. from flowers) must be carefully removed using adhesive tape. Never rub the pollen! Pollen and stains of marker pens cannot be removed. We also wish to draw attention to the presence of plastic protective caps under certain items (e.g. lamps, bowls, phones, laptops) as some pigments in the rubber could cause spots in the mat-natural lacquer. These stains cannot be removed afterwards. To prevent this, always put felt under the rubber feet.

Laminates

Solid wood and duramas with a transparent oil finish

For daily maintenance it is sufficient to clean the table with a dry cloth or lukewarm water if necessary. We recommend removing spilt liquids immediately. Treat the table regularly with oil (twice a year on average) in order to preserve the warm, natural glow of the wood and to provide the wood with the best possible protection against the effects of substances such as liquids. We supply a special maintenance kit together with an oiled table, including a bottle of oil (apply a thin layer of oil on a clean, dry table, distribute well and polish with a dry cloth). You can also use a good quality teak oil (see the packaging or product documentation for instructions). Treat your table regularly with oil to provide the wood with proper care and protection, thereby promoting the longevity of your table. You can easily remove light scratches and stains yourself. The special maintenance kit also contains a ball of steel wool to lightly sand the table top. It is important to sand the entire table top (not only the location of the stain or scratch), and always work in the direction of the grain. After sanding, treat the table with oil or teak oil. Avoid using caustic or abrasive cleaning agents.

Solid wood and duramas with a white oil finish

For daily maintenance it is sufficient to clean the table with a dry cloth or lukewarm water if necessary. We recommend removing spilt liquids immediately. To protect the wood against scratches and the influence of substances such as liquids, the table should be treated a few times a year with white oil. A bottle of white oil is provided for this purpose. Apply a thin layer of oil, using a clean, lint-free cloth and allow it to soak for a few minutes. Use a clean cloth to wipe it away. Always try first on an unnoted area.

NB: Do not sand the table top.

Smoked oak

See maintenance for solid wood and duramas with the respective finish (N-, P-lacquer or oil (only solid)).

Brushed oak

See maintenance for solid wood and duramas with the respective lacquer finish (N- or P-lacquer). However, dirt and moisture can remain in the 'seams/grooves', which can work their way into the wood. It is therefore advisable to quickly remove moisture and dirt.

HPL Fenix NTM®

For daily maintenance it is sufficient to clean the surface with a damp cloth with warm water and mild detergent when necessary. We recommend using acetone for persistent dirt. Superficial scratches can be polished away by friction using a sponge. The warmth generated by rubbing closes the molecules, causing the scratches to disappear.

Forbo Furniture Linoleum

For daily maintenance, we recommend wiping the surface with a damp cloth using warm water. If necessary, use a mild detergent (ZO Schoon or a pH neutral soap). Always rinse thoroughly with clean water to remove any detergent used. Allow the surface to dry thoroughly.

Important: Immediately remove any spillages (including ink, coffee, tea, red wine). Prevent stubborn stains (rings) and scratches from sharp objects; use coasters with a soft underside for cups, glasses, vases, etc.

Metal

Finish: epoxy fine texture

Keep clean with a soft, lint-free, dry cloth and mild soapy water.

Finish: Chrome/stainless steel/stainless steel optic

It is sufficient to rub with a soft, dry cloth or to clean with mild soapy water. Moisten lightly with methylated spirit if necessary. Rub with acidfree vaseline once a year.

Finish: Casted aluminium

See chrome/stainless steel/stainless steel optic. Superficial scratches on a casted aluminium base can be removed with soapy water and Scotch Brite. Always work in the polishing direction.

Concrete

For maintenance instructions for concrete, see 'wood (veneer, solid, duramas) and color lacquer with P-finish'.

Textile

Keep the chair or sofa dust free by using a soft brush or vacuum cleaner (with a soft brush tip). Use a foaming agent to clean the furniture. It is difficult to provide instructions for removing stains in a nutshell, as it varies by type of stain and material. For treating stains, please see <http://www.james.eu/en/stain-removal>. The following applies for all agents: first try carefully on a spot that is not directly visible. Never use too excessive amounts of agents to prevent discoloration and to prevent damage to the foam layer.

Leather

Aniline leather (Leathers in group B and D)

For maintenance of this type of leather, regularly wipe down with a soft dry cloth. Aniline leather should be treated once a year with a leather protective agent for full-aniline leather. Please note! In the case of spills, dab the liquid immediately (do not rub). See www.ohmannleather.com for leather maintenance products.

Semi-aniline and dyed leather

For maintenance of this type of leather, regularly wipe down with a soft dry cloth, a soft brush or a moist cloth if necessary. It is recommended to treat this leather twice a year with a leather nourishing agent. See www.ohmannleather.com for leather maintenance products.

Warranty

Every piece of Arco furniture is produced from especially high quality materials and manufactured with the greatest care. The furniture only leaves our factory after careful quality control. If, despite of this, component or manufacturing faults occur, Arco will cover the cost of replacement or repair according to the following schedule:

Years of use contribution from Arco (in percentage of costs):

0-1	100 %
1-2	80 %
2-3	60 %
3-4	40 %
4-5	20 %

As condition we give that our maintenance advice has been used correctly. Furthermore, we are talking about normal, domestic use. Defects which are a result of injudicious use are excluded from warranty.

We also like to point out to you again the fact that wood is a natural material. For example, the final colour of the wood develops under the influence of light during use (ask you dealer for explanation and advice). For an equal colouring, it is advisable to also place the extra leaves in the same light during the first months. Very important for the condition of the wood is to maintain the humidity of the air as constant as possible (approx. 60%) in order to avoid drying out of the wood (shrinkage!).

A warranty claim to Arco has to be made within the warranty period, which starts on the day of delivery to the first owner or at the latest 30 days after delivery from Arco to the Arco dealer. Submitting a claim has to be done by presenting the invoice and the warranty certificate.

Specific exclusions

1. Normal wear and tear and damage are not covered by the warranty.
2. Damage due to incorrect use or wrong maintenance are excluded from warranty.
3. Indirect damage due to a possible defect, such as loss of profits, etc., are also excluded from warranty.
4. Repairs to the furniture and/or upholstery without written permission from Arco, are not covered by the warranty.
5. Chairs: the Arco warranty conditions do not apply for leather and fabric upholstery which are not from the standard Arco collection (e.g. customer own materials).

Tables

p. 26	Balance
p. 30	Base
p. 34	Cast
p. 38	Dew
p. 40	Essential
p. 44	Essenza
p. 52	Extend
p. 56	Grid
p. 64	HAT
p. 66	Joist
p. 70	Kami
p. 78	Move
p. 82	Shift
p. 86	Slim
p. 92	Slim+
p. 98	Spazio
p. 102	Trestle
p. 107	Cable Management

we make tables

Table Overview

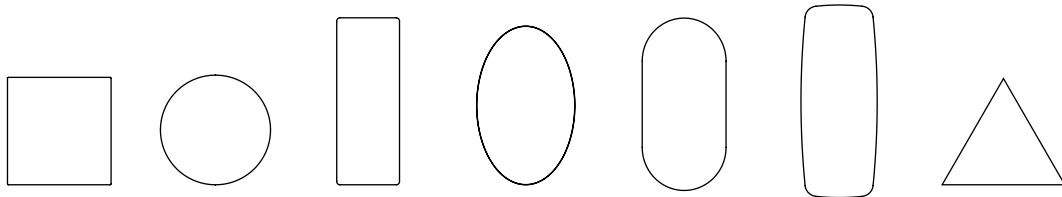

Shape	Square	Round	Rectangular	Ellipse	Oval	Barrel	Triangle	Page
Balance		X		X				26
Base			X					30
Cast			X					34
Dew					X			38
Essential			X			X		40
Essenza			X					44
Extend			X					52
Grid	X	X	X			X		56
HAT			X					64
Joist		X		X				66
Kami		X			X			70
Move							X	78
Shift			X					82
Slim	X		X					86
Slim+		X	X					92
Spazio				X				98
Trestle			X					102

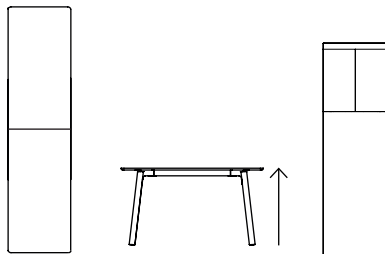

Shape	Connected	High	Extendable	Page
Balance			X	26
Base	X			30
Cast	X			34
Dew				38
Essential				40
Essenza	X	X		44
Extend			X	52
Grid	X	X		56
HAT		X		64
Joist				66
Kami	X			70
Move		X		78
Shift			X	82
Slim				86
Slim+	X	X		92
Spazio			X	98
Trestle	X			102

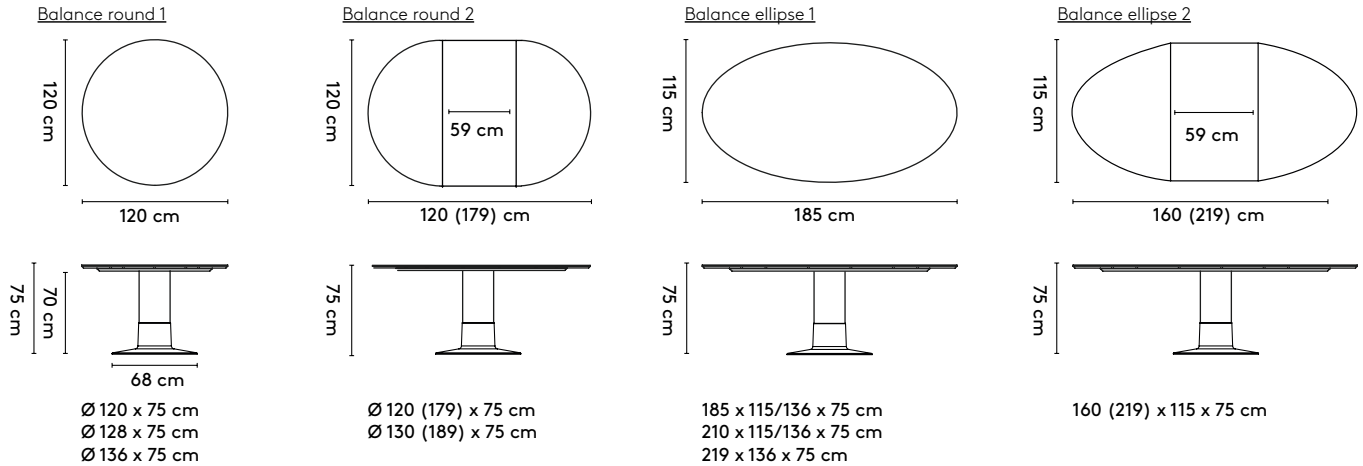
1 **Balance****Arnold
Merckx****1988**2a **Standard**2b **Tailoring**3 **Materials**

Top: oak or walnut (solid, veneer, duramas), oak smoked (solid), Fenix® HPL
Extension leaf: oak or walnut (veneer, duramas), Fenix® HPL
Column: oak or walnut (veneer), color lacquer on multiplex
Base: epoxy fine texture on aluminium, brushed aluminium

Materialen

Blad: eiken of noten (massief, fineer, duramas), gerookt eiken (massief), Fenix® HPL
Uitschuifblad: eiken of noten (fineer, duramas), Fenix® HPL
Kolom: eiken of noten (fineer), kleurlak op multiplex
Voet: epoxy fine texture op aluminium, aluminium geborsteld

Materialien

Platte: Eiche oder Nussbaum (Massiv, Furnier, Duramas), Eiche geräuchert (Massiv), Fenix® HPL
Einlegeplatte: Eiche oder Nussbaum (Furnier, Duramas), Fenix® HPL
Säule: Eiche oder Nussbaum (Furnier), Farblack auf Multiplex
Fuss: Epoxy fine texture auf Aluminium, gebürstetes Aluminium

4 **Finishes**

All Arco colors and finishes for the mentioned materials

Afwerkingen

Alle Arco kleuren en (lak)afwerkingen voor de genoemde materialen

Ausführungen

Alle Arco Farben und Ausführungen für die genannten Materialien

5 **Additional information**

-

Aanvullende informatie

-

Weitere Informationen

-

6 **Cable management**

-

product

1 **Balance**2a **Standard**Balance round 1

version	dimensions	oak				smoked oak		walnut			Fenix® HPL	transport information		
		veneer	duramas	solid	brushed solid	solid	brushed solid	veneer	duramas	solid	Fenix® HPL	colli	m3	kg
Balance round 1	120x75cm	€ 4000	€ 4441	€ 4871	€ 5355	€ 5899	€ 6486	€ 4393	€ 5076	€ 6057	€ 4526	4	0.58	54
Balance round 1	128x75cm	€ 4054	€ 4635	€ 5113	€ 5621	€ 6190	€ 6801	€ 4598	€ 5306	€ 6353	€ 4701	4	0.62	60
Balance round 1	136x75cm			€ 5197		€ 6311				€ 6474		4	0.68	67

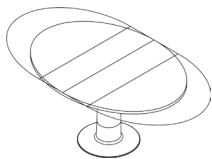
Balance round 2

version	dimensions	oak		walnut		Fenix® HPL	transport information		
		veneer	duramas	veneer	duramas	Fenix® HPL	colli	m3	kg
Balance round 2	120(179)x75cm	€ 4641	€ 5107	€ 5107	€ 5730	€ 5439	5	0.58	68
Balance round 2	130(189)x75cm	€ 4828	€ 5337	€ 5318	€ 6002	€ 5669	5	0.64	76

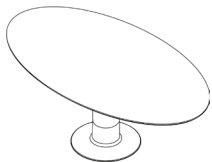
Balance ellipse 1

version	dimensions	oak				smoked oak		walnut			Fenix® HPL	transport information		
		veneer	duramas	solid	brushed solid	solid	brushed solid	veneer	duramas	solid	Fenix® HPL	colli	m3	kg
Balance ellipse 1	185x115x75cm	€ 4272	€ 4732	€ 5288	€ 5730	€ 6311	€ 6946	€ 4695	€ 5427	€ 6480	€ 4834	4	0.74	70
Balance ellipse 1	185x136x75cm			€ 5802		€ 7055				€ 7127		4	0.74	74
Balance ellipse 1	210x115x75cm			€ 5694	€ 6262	€ 6922	€ 7617			€ 7158	€ 5131	4	0.80	81
Balance ellipse 1	210x136x75cm			€ 6214		€ 7545				€ 7617		4	0.80	81
Balance ellipse 1	219x136x75cm			€ 6226		€ 7557				€ 7630		4	0.83	96

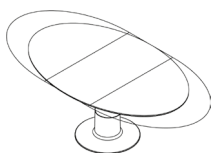
Balance ellipse 2

version	dimensions	oak		walnut		Fenix® HPL	transport information		
		veneer	duramas	veneer	duramas	Fenix® HPL	colli	m3	kg
Balance ellipse 2	160(219)x115x75cm	€ 4974	€ 5560	€ 5488	€ 6165	€ 5851	5	0.68	78

product

1 Balance

2b Tailoring

Possible for solid tables.

Within the limits indicated on the factsheet: price of the next larger length or width with a surcharge of € 275 (gross incl. VAT).
In case of a deviation in both length and width, the next length size is considered first and then the next larger width.

3 Materials

-

4 Finishes

For an overview of all current Arco colors, please refer to this price list page 5 ff or visit our website www.arco.nl.

5 Additional information

-

6 Cable management

-

Ordering support

	example
type	Balance ellipse 1
size	185x115x73cm
material top	walnut duramas
color top	1000 - pure
finish top	N-lacquer
material column	walnut veneer
color column	1000 - pure
finish column	N-lacquer
material base	aluminum
color base	5301 - RAL 9005 black

1 **Base**

**Jorre
van Ast**

2013 - 2016

2a **Standard**

Base rectangular 2

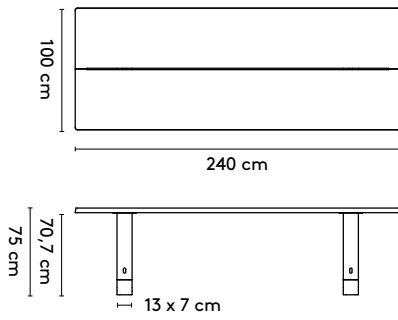

240 x 100/128/140 x 75 cm (between legs 170/150/130/110 cm)
 280 x 100/120/140 x 75 cm (between legs 210/190/170/150 cm)
 320 x 105/120/140 x 75 cm (between legs 250/230/210/190 cm)
 360 x 105/120/140 x 75 cm (between legs 230 cm)

Base rectangular 2 connected

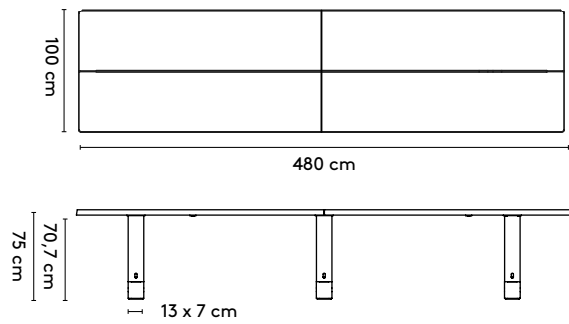

480 x 100/140 x 75 cm (between legs 192/182/172/162 cm)
 560 x 100/120/140 x 75 cm (between legs 232/222/212/202 cm)

Base bench

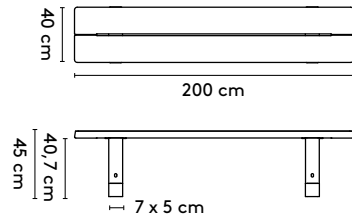

200 x 40 x 45 cm
 240 x 40 x 45 cm
 280 x 40 x 45 cm
 320 x 40 x 45 cm

2b **Tailoring**

Base rectangular 2

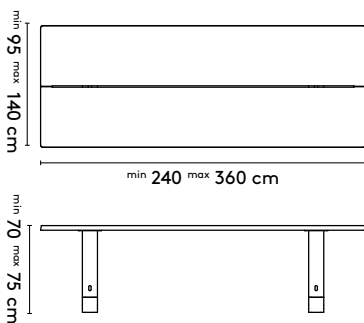

Base rectangular 2 connected

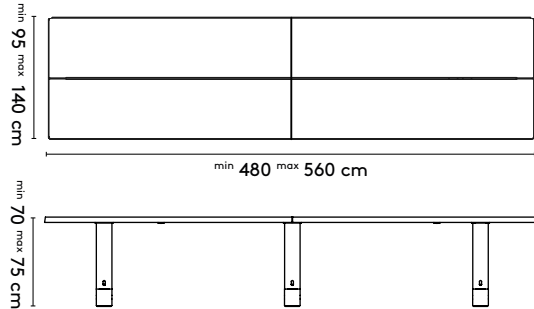

Base bench

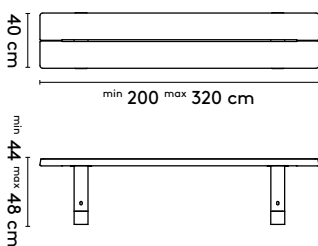

1 Base

<p>3 <u>Materials</u></p> <p>Top: oak (solid, local wood) or walnut (solid), oak smoked (solid) Legs: oak (solid, local wood), walnut (solid), oak smoked (solid) Base: concrete (natural, color laquer)</p>	<p><u>Materialen</u></p> <p>Blad: eiken (massief, lokaal hout) of noten (massief), eiken gerookt (massief) Onderstel: eiken (massief, lokaal hout), noten (massief), eiken gerookt (massief) Voet: beton (natural, kleurlak)</p>	<p><u>Materialien</u></p> <p>Platte: Eiche (Massiv, lokales Holz) oder Nussbaum (Massiv), Eiche geräuchert (Massiv) Untergestell: Eiche (Massiv, lokales Holz), Nussbaum (Massiv), Eiche geräuchert (Massiv) Fuss: Beton (natural, farblack)</p>
<p>4 <u>Finishes</u></p> <p>All Arco colors and finishes for the mentioned materials</p>	<p><u>Afwerkingen</u></p> <p>Alle Arco kleuren en (lak)afwerkingen voor de genoemde materialen</p>	<p><u>Ausführungen</u></p> <p>Alle Arco Farben und Ausführungen für die genannten Materialien</p>
<p>5 <u>Additional information</u></p> <p>Legs can be mounted at 22, 32, 42 or 52 cm from the short side of the table. Legs can be mounted at 52 cm only for size 360 cm</p>	<p><u>Aanvullende informatie</u></p> <p>Onderstel kan worden gemonteerd op 22, 32, 42 of 52 cm van de korte zijde van de tafel Onderstel kan bij 360 cm alleen op 52 cm worden gemonteerd</p>	<p><u>Weitere Informationen</u></p> <p>Untergestell kann auf 22, 32, 42 oder 52 cm der kurze Seite des Tisches montiert werden Untergestell kann bei 360 cm nur auf 52 cm montiert werden</p>

6 Cable management

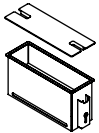

CM06/CM07
epoxy
30/50 cm



CM15
EVOline® One spot
Ø 5,9 cm



CM08/CM09
cable-net
small/large



CM12
cable sock
large



CM13
zipper sock
short

product

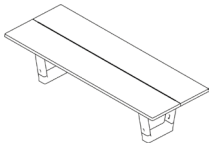
1 **Base**2a **Standard**Base rectangular 2

version	dimensions	local oak		smoked oak		walnut	transport information		
		solid	brushed solid	solid	brushed solid	solid	colli	m3	kg
Base rectangular 2	240x100x75cm	€ 5639	€ 5972	€ 6649	€ 7315	€ 8906	5	0.44	127
Base rectangular 2	240x128x75cm	€ 6510	€ 7164	€ 7980	€ 8779	€ 10685	5	0.49	159
Base rectangular 2	240x140x75cm	€ 6970	€ 7666	€ 8543	€ 9390	€ 11435	5	0.53	168
Base rectangular 2	280x100x75cm	€ 6099	€ 6474	€ 7297	€ 8023	€ 10062	5	0.55	141
Base rectangular 2	280x120x75cm	€ 6891	€ 7315	€ 8132	€ 8948	€ 11054	5	0.53	168
Base rectangular 2	280x140x75cm	€ 7593	€ 8349	€ 8967	€ 9856	€ 12802	5	0.57	187
Base rectangular 2	320x105x75cm	€ 6789	€ 7460	€ 8023	€ 8821	€ 11163	5	0.53	159
Base rectangular 2	320x120x75cm	€ 7448	€ 8192	€ 8785	€ 9662	€ 12548	5	0.57	184
Base rectangular 2	320x140x75cm	€ 8107	€ 8918	€ 9729	€ 10479	€ 14133	5	0.64	205
Base rectangular 2	360x105x75cm	€ 7363	€ 8114	€ 8670	€ 9535	€ 12234	5	0.57	173
Base rectangular 2	360x120x75cm	€ 7865	€ 8664	€ 9438	€ 10171	€ 13722	5	0.61	200
Base rectangular 2	360x140x75cm	€ 8809	€ 9705	€ 10576	€ 11387	€ 15361	5	0.68	224

Base rectangular 2 connected

version	dimensions	local oak		smoked oak		walnut	transport information		
		solid	brushed solid	solid	brushed solid	solid	colli	m3	kg
Base rectangular 2 connected	480x100x75cm	€ 9910	€ 10909	€ 12639	€ 13897	€ 17334	8	1.40	220
Base rectangular 2 connected	480x140x75cm	€ 11604	€ 12766	€ 14787	€ 16257	€ 20286	8	1.25	220
Base rectangular 2 connected	560x100x75cm	€ 10739	€ 11822	€ 13825	€ 15216	€ 18338	8	1.80	260
Base rectangular 2 connected	560x120x75cm	€ 12137	€ 13323	€ 15446	€ 17001	€ 20486	8	1.80	300
Base rectangular 2 connected	560x140x75cm	€ 14200	€ 15591	€ 18072	€ 19893	€ 23965	8	1.65	300

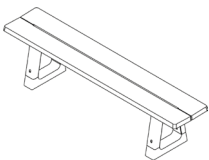
Base bench

version	dimensions	local oak		smoked oak		walnut	transport information		
		solid	brushed solid	solid	brushed solid	solid	colli	m3	kg
Base bench	200x40x45cm	€ 2475	€ 2675	€ 3019	€ 3346	€ 4018	4	0.07	44
Base bench	240x40x45cm	€ 2669	€ 2886	€ 3274	€ 3594	€ 4393	4	0.09	49
Base bench	280x40x45cm	€ 2850	€ 3140	€ 3497	€ 3842	€ 4774	4	0.09	53
Base bench	320x40x45cm	€ 3140	€ 3401	€ 3866	€ 4254	€ 5119	4	0.09	58

product

1 Base

2b Tailoring

Within the limits indicated on the factsheet: price of the next larger length or width with a surcharge of € 275 (gross incl. VAT). In case of a deviation in both length and width, the next length size is considered first and then the next larger width.

3 Materials

-

4 Finishes

For an overview of all current Arco colors, please refer to this price list page 5 ff or visit our website www.arco.nl.

5 Additional information

-

6 Cable management

CM06	CM07	CM15	CM08	CM09	CM12	CM13
€ 545	€ 587	€ 152	€ 97	€ 128	€ 79	€ 97

Ordering support

	example
type	Base rectangular 2
size	320x105x75cm
material top	oak local wood
color top	1100 - natural
material legs	oak local wood
color legs	1100 - natural
finish table	N-lacquer
color concrete base	natural

1 **Cast****Jorre
van Ast**

2019

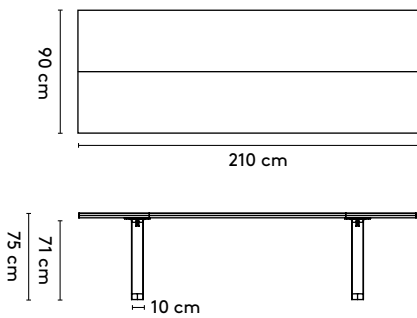
2a **Standard**Cast rectangular 2

210 x 95/128 x 75 cm (between legs: 150/130/110cm)
 240 x 100/128 x 75 cm (between legs: 180/160/140cm)
 280 x 100/128 x 75 cm (between legs: 220/200/180cm)
 320 x 105/128 x 75 cm (between legs: 260/240/220cm)
 360 x 105/128 x 75 cm (between legs: 260cm)

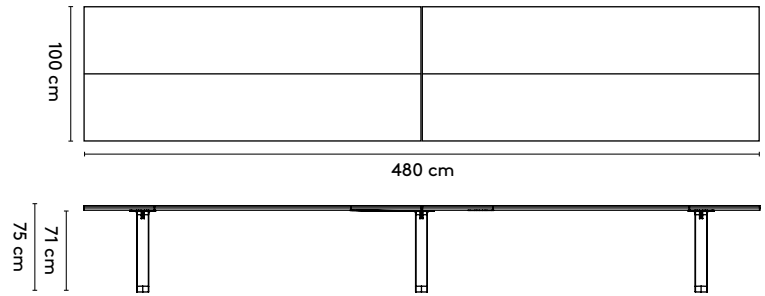
Cast rectangular 2 connected

480 x 100/128 x 75 cm (between legs: 195/185/175 cm)
 560 x 100/128 x 75 cm (between legs: 235/225/215 cm)

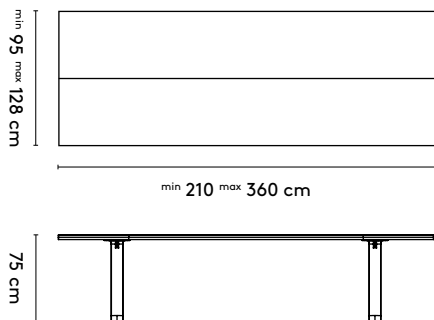
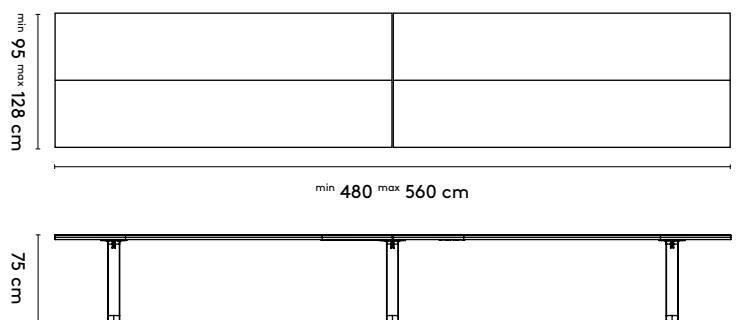
2b **Tailoring**Cast rectangular 2Cast rectangular 2 connected3 **Materials**

Top: oak (solid, local wood) or walnut (solid), oak smoked (solid)
Legs: epoxy fine texture on aluminum

Materialen

Blad: eiken (massief, lokaal hout) of noten (massief), eiken gerookt (massief)
Onderstel: epoxy fine texture op aluminium

Materialien

Platte: Eiche (Massiv, lokales Holz) oder Nussbaum (Massiv), Eiche geräuchert (Massiv)
Untergestell: Epoxy fine texture auf Aluminium

4 **Finishes**

All Arco colors and finishes for the mentioned materials

Afwerkingen

Alle Arco kleuren en (lak)afwerkingen voor de genoemde materialen

Ausführungen

Alle Arco Farben und Ausführungen für die genannten Materialien

5 **Additional information**

Legs can be mounted at 25, 35 or 45 cm from the short side of the table

Aanvullende informatie

Onderstel kan worden gemonteerd op 25, 35 of 45 cm van de korte zijde van de tafel

Weitere Informationen

Untergestell kann auf 25, 35 und 45 cm der kurze Seite des Tisches montiert werden

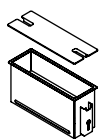
6 **Cable management**

CM06/CM07
epoxy
30/50 cm



CM15
EVOLine® One spot
Ø 5,9 cm

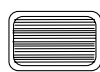

CM08/CM09
cable-net
small / large



CM12
cable sock
large



CM13
zipper sock
short

product

1 Cast

2a Standard

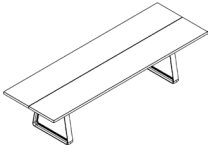

Cast rectangular 2

version	dimensions	local oak		smoked oak		walnut	transport information		
		solid	brushed solid	solid	brushed solid	solid	colli	m3	kg
Cast rectangular 2	210x95x75cm	€ 4877	€ 5161	€ 5730	€ 6286	€ 7291	5	0.33	92
Cast rectangular 2	210x128x75cm	€ 5585	€ 6038	€ 6577	€ 7097	€ 8610	5	0.40	115
Cast rectangular 2	240x100x75cm	€ 5318	€ 5839	€ 6256	€ 6879	€ 8089	5	0.36	105
Cast rectangular 2	240x128x75cm	€ 6220	€ 6849	€ 7321	€ 8053	€ 9777	5	0.41	127
Cast rectangular 2	280x100x75cm	€ 5706	€ 6292	€ 6722	€ 7388	€ 8967	5	0.40	118
Cast rectangular 2	280x128x75cm	€ 6891	€ 7406	€ 8107	€ 8737	€ 11096	5	0.48	145
Cast rectangular 2	320x105x75cm	€ 6432	€ 6922	€ 7575	€ 8168	€ 10370	5	0.45	136
Cast rectangular 2	320x128x75cm	€ 7539	€ 8277	€ 8870	€ 9741	€ 11986	5	0.52	161
Cast rectangular 2	360x105x75cm	€ 7055	€ 7732	€ 8283	€ 9106	€ 11199	5	0.49	150
Cast rectangular 2	360x128x75cm	€ 8458	€ 9281	€ 9947	€ 10933	€ 13438	5	0.56	178



Cast rectangular 2 connected

version	dimensions	local oak		smoked oak		walnut	transport information		
		solid	brushed solid	solid	brushed solid	solid	colli	m3	kg
Cast rectangular 2 connected	480x100x75cm	€ 9348	€ 10255	€ 11877	€ 13075	€ 15930	5	1.40	300
Cast rectangular 2 connected	480x128x75cm	€ 10939	€ 12058	€ 13909	€ 15301	€ 18634	5	1.25	300
Cast rectangular 2 connected	560x100x75cm	€ 10031	€ 11060	€ 12760	€ 14036	€ 17098	5	1.80	360
Cast rectangular 2 connected	560x128x75cm	€ 12536	€ 13825	€ 15948	€ 17545	€ 21369	5	1.65	360

2b Tailoring

Within the limits indicated on the factsheet: price of the next larger length or width with a surcharge of € 275 (gross incl. VAT). In case of a deviation in both length and width, the next length size is considered first and then the next larger width.

3 Materials

-

4 Finishes

For an overview of all current Arco colors, please refer to this price list page 5 ff or visit our website www.arco.nl.

5 Additional information

-

product

1 **Cast**6 **Cable management**

CM06 € 545	CM07 € 587	CM15 € 152	CM08 € 97	CM09 € 128	CM12 € 79	CM13 € 97
---------------	---------------	---------------	--------------	---------------	--------------	--------------

Ordering support

type
size
material top
color top
material frame
finish table
color frame

example

Cast rectangular 2
320x105x75cm
oak local wood
1101 - white
epoxy fine texture
N-lacquer
5301 - RAL 9005 black

product

designer

year

1 Dew

Sabine Marcelis

2022 - 2024

2 Standard

Dew

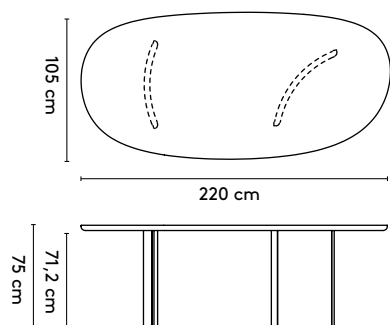

220 x 105 x 75 cm
 270 x 115 x 75 cm
 300 x 120 x 75 cm
 330 x 125 x 75 cm

3 Materials

Top: oak or walnut (solid, duramas), oak smoked (solid, duramas)
Columns: oak or walnut (duramas), oak smoked (duramas)

Materialen

Blad: eiken of noten (massief, duramas), gerookt eiken (massief, duramas)
 Kolommen: eiken of noten (duramas), gerookt eiken (duramas)

Materialien

Platte: Eiche oder Nussbaum (Massiv, Duramas), Eiche geräuchert (Massiv, Duramas)
 Säule: Eiche oder Nussbaum (Duramas), Eiche geräuchert (Duramas)

4 Finishes

All Arco colors and finishes for the mentioned materials

Afwerkingen

Alle Arco kleuren en (lak)afwerkingen voor de genoemde materialen

Ausführungen

Alle Arco Farben und Ausführungen für die genannten Materialien

5 Additional information

-

Aanvullende informatie

-

Weitere Informationen

-

6 Cable management



CM15
 EVoline® One spot
 Ø 5,9 cm

product

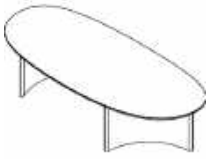
1 **Dew**2a **Standard**

Dew

version	dimensions	oak		smoked oak		walnut		transport information		
		duramas	solid	duramas	solid	duramas	solid	colli	m3	kg
Dew	220x105x75	€ 5603	€ 6280	€ 6002	€ 7315	€ 6867	€ 8900	3	1.00	73
Dew	270x115x75	€ 6438	€ 7636	€ 7043	€ 9021	€ 8023	€ 11163	3	1.10	94
Dew	300x120x75	€ 7200	€ 8706	€ 7702	€ 10394	€ 8954	€ 13450	3	1.16	106
Dew	330x125x75	€ 7636	€ 9445	€ 8071	€ 11060	€ 9324	€ 14018	3	1.40	118

3 **Materials**

-

4 **Finishes**

For an overview of all current Arco colors, please refer to this price list page 5 ff or visit our website www.arco.nl.

5 **Additional information**

-

6 **Cable management**

CM15
€ 152

Ordering support

type
size
material table
color table
finish table

example

Dew
270x115x75cm
oak solid
1400 - terra
N-lacquer

1 **Essential****Gudmundur
Ludvik**

2020 - 2024

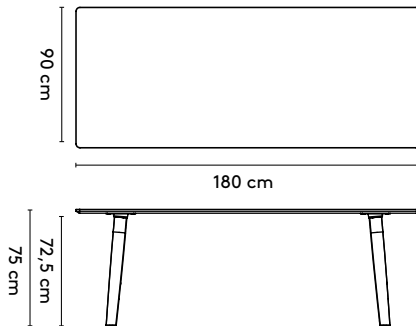
2a **Standard**Essential Rectangular 1

180 x 90 x 75 cm (between legs: 130 cm)
 200 x 90 x 75 cm (between legs: 140 cm)
 220 x 90 x 75 cm (between legs: 155 cm)
 240 x 90 x 75 cm (between legs: 165 cm)
 260 x 90 x 75 cm (between legs: 185 cm)
 280 x 90 x 75 cm (between legs: 190 cm)

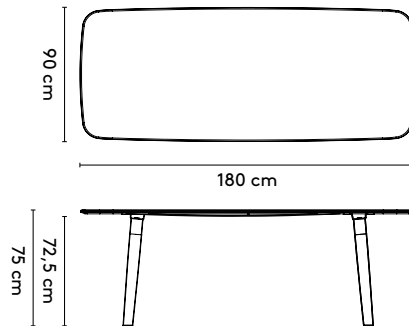
Essential Barrel 1

180 x 90 x 75 cm (between legs: 130 cm)
 200 x 90 x 75 cm (between legs: 140 cm)
 220 x 90 x 75 cm (between legs: 155 cm)
 240 x 90 x 75 cm (between legs: 165 cm)
 260 x 90 x 75 cm (between legs: 185 cm)
 280 x 90 x 75 cm (between legs: 190 cm)

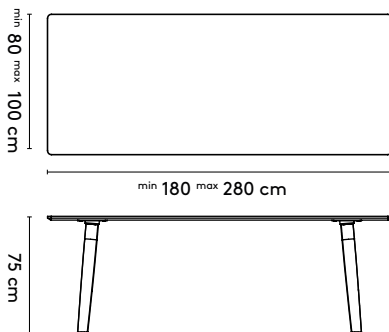
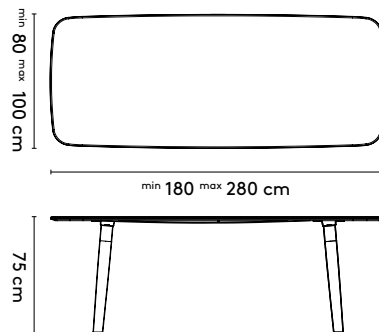
2b **Tailoring**Essential Rectangular 1Essential Barrel 13 **Materials**

Top Rectangular: oak or walnut (veneer), Fenix® HPL, linoleum (Forbo Furniture coll.)
Top Barrel: oak, oak smoked or walnut (solid)
Legs: beech laminate with oak or walnut top layer

Materialen

Blad Rectangular: eiken of noten (fineer), Fenix® HPL, linoleum (Forbo Furniture coll.)
 Blad Barrel: eiken, gerookt eiken of noten (massief)
 Onderstel: beuken laminaat met eiken of noten toplaag

Materialien

Platte Rectangular: Eiche oder Nussbaum (Furnier), Fenix® HPL, Linoleum, (Forbo Furniture coll.)
 Platte Barrel: Eiche, Eiche geräuchert oder Nussbaum (Massiv)
 Untergestell: Buche Laminate mit Eiche oder Nussbaum Oberbeschichtung

4 **Finishes**

All Arco colors and finishes for the mentioned materials

Afwerkingen

Alle Arco kleuren en (lak)afwerkingen voor de genoemde materialen

Ausführungen

Alle Arco Farben und Ausführungen für die genannten Materialien

5 **Additional information**

-

Aanvullende informatie

-

Weitere Informationen

-

6 **Cable management**

CM15
 EVOLine® One spot
 Ø 5,9 cm

product

1 Essential

2 Standard



Essential Rectangular 1

version	dimensions	Oak	Walnut	Fenix® HPL		linoleum		transport information		
		veneer	veneer	Fenix® HPL, oak legs	Fenix® HPL, walnut legs	linoleum, oak legs	linoleum, walnut legs	colli	m3	kg
Essential Rectangular 1	180x90x75cm	€ 2160	€ 2414	€ 2977	€ 3001	€ 2596	€ 2650	4	0.59	45
Essential Rectangular 1	200x90x75cm	€ 2251	€ 2523	€ 3056	€ 3080	€ 2729	€ 2777	4	0.60	48
Essential Rectangular 1	220x90x75cm	€ 2330	€ 2590	€ 3086	€ 3110	€ 2808	€ 2856	4	0.61	51
Essential Rectangular 1	240x90x75cm	€ 2614	€ 2935	€ 3395	€ 3425	€ 3171	€ 3219	4	0.63	63
Essential Rectangular 1	260x90x75cm	€ 2765	€ 3110	€ 3455	€ 3479	€ 3274	€ 3328	4	0.64	67
Essential Rectangular 1	280x90x75cm	€ 2911	€ 3201	€ 3509	€ 3534	€ 3382	€ 3431	4	0.65	71

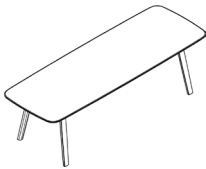

Essential Barrel 1

version	dimensions	Oak		smoked oak	Walnut	transport information		
		solid	brushed solid	solid	solid	colli	m3	kg
Essential Barrel 1	180x90x75cm	€ 3098	€ 3407	€ 3382	€ 4211	4	0.59	45
Essential Barrel 1	200x90x75cm	€ 3189	€ 3509	€ 3509	€ 4387	4	0.60	48
Essential Barrel 1	220x90x75cm	€ 3503	€ 3854	€ 3860	€ 4828	4	0.61	51
Essential Barrel 1	240x90x75cm	€ 3637	€ 4000	€ 4024	€ 5040	4	0.63	54
Essential Barrel 1	260x90x75cm	€ 4012	€ 4411	€ 4435	€ 5554	4	0.64	58
Essential Barrel 1	280x90x75cm	€ 4393	€ 4834	€ 4865	€ 6093	4	0.65	62

2b Tailoring

Within the limits indicated on the factsheet: price of the next larger length or width with a surcharge of € 275 (gross incl. VAT). In case of a deviation in both length and width, the next length size is considered first and then the next larger width.

3 Materials

-

4 Finishes

For an overview of all current Arco colors, please refer to this price list page 5 ff or visit our website www.arco.nl.

5 Additional information

-

product

1 Essential

6 Cable management

CM15
€ 152

Ordering support

type
size
material top
color top
material legs
color legs
finish table

example

Essential Barrel 1
220x90x75cm
oak veneer
1000 - pure
oak
1000 - pure
N-lacquer

1 **Essenza**

**Willem
van Ast**

1999 - 2024

2a **Standard**

Essenza rectangular 1

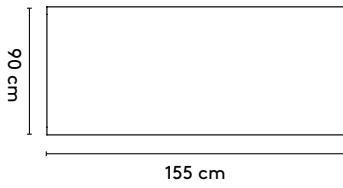

- 155 x 90/110 x 75 cm
- 190 x 90/110 x 75 cm
- 210 x 90/105/110 x 75 cm
- 240 x 90/105/110 x 75 cm
- 280 x 90/110 x 75 cm

Essenza rectangular XL



- 240 x 105/120 x 75 cm
- 280 x 105/120 x 75 cm
- 320 x 105/120 x 75 cm
- 360 x 105 x 75 cm

Essenza rectangular XL high



- 244 x 100 x 107 cm
- 254 x 100 x 107 cm
- 264 x 100 x 107 cm
- 274 x 100 x 107 cm
- 284 x 100 x 107 cm
- 295 x 100 x 107 cm
- 305 x 100 x 107 cm

Essenza rectangular XL high connected

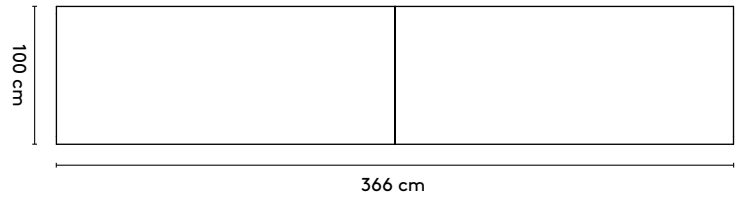

- 366 x 100 x 107 cm
- 376 x 100 x 107 cm
- 386 x 100 x 107 cm
- 396 x 100 x 107 cm
- 406 x 100 x 107 cm
- 417 x 100 x 107 cm
- 427 x 100 x 107 cm
- 437 x 100 x 107 cm
- 447 x 100 x 107 cm
- 457 x 100 x 107 cm
- 467 x 100 x 107 cm
- 478 x 100 x 107 cm
- 488 x 100 x 107 cm
- 498 x 100 x 107 cm
- 508 x 100 x 107 cm
- 518 x 100 x 107 cm

Essenza bench

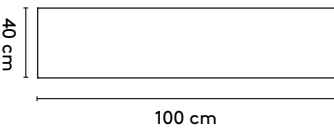

- 100 x 40 x 45 cm
- 150 x 40 x 45 cm
- 180 x 40 x 45 cm
- 220 x 40 x 45 cm

Essenza bench cushion

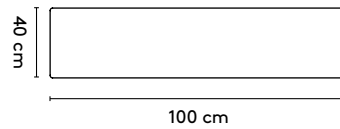

- 100 x 40 cm
- 150 x 40 cm
- 180 x 40 cm
- 220 x 40 cm

1 Essenza

2b Tailoring

Essenza rectangular 1

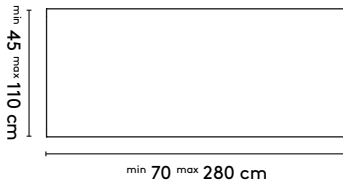

Essenza rectangular XL

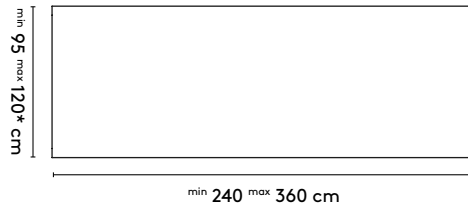

* From length 321 cm only available in max. width of 105 cm

Essenza rectangular XL high

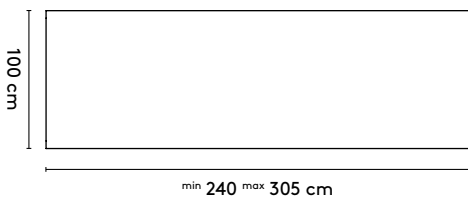

Essenza rectangular XL high connected

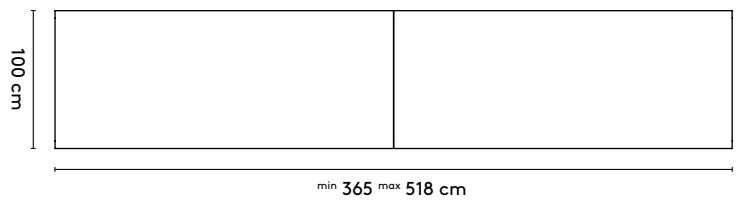

Essenza bench

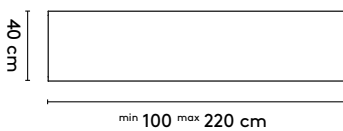

3 Materials

Top: oak or walnut (solid), oak smoked (solid)
Legs: oak or walnut (solid), oak smoked (solid)
Cushion: fabric (see list of fabrics)

Materialen

Blad: eiken of noten (massief), eiken gerookt (massief)
Poten: eiken of noten (massief), eiken gerookt (massief)
Kussen: stof (zie stoffenlijst)

Materialien

Platte: Eiche oder Nussbaum (Massiv), Eiche geräuchert (Massiv)
Beine: Eiche oder Nussbaum (Massiv), Eiche geräuchert (Massiv)
Kissen: Stoff (siehe Stoffliste)

4 Finishes

All Arco colors and finishes for the mentioned materials

Afwerkingen

Alle Arco kleuren en (lak)afwerkingen voor de genoemde materialen

Ausführungen

Alle Arco Farben und Ausführungen für die genannten Materialien

1 **Essenza**

5 **Additional information**

Aanvullende informatie

Weitere Informationen

6 **Cable management**

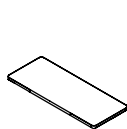

CM04
solid wood
30 x 15 cm

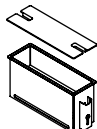

CM06/CM07
epoxy
30/50 cm



CM15
EVOLINE® One spot
Ø 5,9 cm

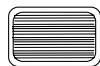

CM08/CM09
cable-net
small/large



CM12
cable sock
large



CM13/CM14
zipper sock
short/long

product

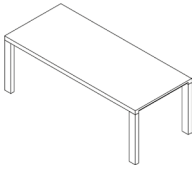
1 **Essenza**2a **Standard**Essenza rectangular 1

version	dimensions	oak		smoked oak		walnut	transport information		
		solid	brushed solid	solid	brushed solid	solid	colli	m3	kg
Essenza rectangular 1	155x90x75cm	€ 2886	€ 3171	€ 3655	€ 4030	€ 4127	3	0.18	48
Essenza rectangular 1	155x110x75cm	€ 3455	€ 3794	€ 4090	€ 4502	€ 4586	3	0.22	55
Essenza rectangular 1	190x90x75cm	€ 3455	€ 3794	€ 4090	€ 4502	€ 4586	3	0.22	55
Essenza rectangular 1	190x110x75cm	€ 3818	€ 4199	€ 4847	€ 5331	€ 5445	3	0.26	63
Essenza rectangular 1	210x90x75cm	€ 3715	€ 4084	€ 4719	€ 5191	€ 5282	3	0.24	61
Essenza rectangular 1	210x105x75cm	€ 4018	€ 4429	€ 5107	€ 5609	€ 5730	3	0.28	68
Essenza rectangular 1	210x110x75cm	€ 4181	€ 4605	€ 5306	€ 5833	€ 5954	3	0.30	71
Essenza rectangular 1	240x90x75cm	€ 4054	€ 4459	€ 5161	€ 5663	€ 5784	3	0.28	67
Essenza rectangular 1	240x105x75cm	€ 4435	€ 4871	€ 5627	€ 6190	€ 6323	3	0.32	74
Essenza rectangular 1	240x110x75cm	€ 4635	€ 5095	€ 5887	€ 6468	€ 6613	3	0.34	77
Essenza rectangular 1	280x90x75cm	€ 5004	€ 5506	€ 6341	€ 6988	€ 6704	3	0.32	76
Essenza rectangular 1	280x110x75cm	€ 6401	€ 7049	€ 8156	€ 8967	€ 9142	3	0.38	88

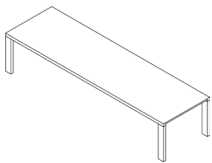
Essenza rectangular XL

version	dimensions	oak		smoked oak		walnut	transport information		
		solid	brushed solid	solid	brushed solid	solid	colli	m3	kg
Essenza rectangular XL	240x105x75cm	€ 5004	€ 5506	€ 6341	€ 6988	€ 6704	3	0.32	81
Essenza rectangular XL	240x120x75cm	€ 6002	€ 6607	€ 7642	€ 8410	€ 8573	3	0.36	89
Essenza rectangular XL	280x105x75cm	€ 6123	€ 6746	€ 7799	€ 8579	€ 8749	3	0.38	90
Essenza rectangular XL	280x120x75cm	€ 6740	€ 7406	€ 8579	€ 9426	€ 9662	3	0.42	99
Essenza rectangular XL	320x105x75cm	€ 6740	€ 7406	€ 8579	€ 9426	€ 9662	3	0.42	100
Essenza rectangular XL	320x120x75cm	€ 7430	€ 8174	€ 9457	€ 10394	€ 10679	3	0.48	111
Essenza rectangular XL	360x105x75cm	€ 7357	€ 8089	€ 9360	€ 10298	€ 10570	3	0.48	108

product

1 **Essenza**2a **Standard**

Essenza XL high

version	dimensions	oak	transport information		
			solid	colli	m3
Essenza XL high	244x100x107cm	€ 8930	4	0.22	121
Essenza XL high	254x100x107cm	€ 9051	4	0.22	124
Essenza XL high	264x100x107cm	€ 9184	4	0.23	126
Essenza XL high	274x100x107cm	€ 9305	4	0.24	128
Essenza XL high	284x100x107cm	€ 9481	4	0.24	131
Essenza XL high	295x100x107cm	€ 9620	4	0.25	134
Essenza XL high	305x100x107cm	€ 9741	4	0.25	136



Essenza XL high connected

version	dimensions	oak	transport information		
			solid	colli	m3
Essenza XL high connected	366x100x107cm	€ 13298	6	0.34	186
Essenza XL high connected	376x100x107cm	€ 13389	6	0.34	188
Essenza XL high connected	386x100x107cm	€ 13480	6	0.34	190
Essenza XL high connected	396x100x107cm	€ 13619	6	0.35	192
Essenza XL high connected	406x100x107cm	€ 13740	6	0.36	194
Essenza XL high connected	417x100x107cm	€ 13837	6	0.36	196
Essenza XL high connected	427x100x107cm	€ 13970	6	0.37	199
Essenza XL high connected	437x100x107cm	€ 14061	6	0.37	200
Essenza XL high connected	447x100x107cm	€ 14182	6	0.38	203
Essenza XL high connected	457x100x107cm	€ 14285	6	0.38	204
Essenza XL high connected	467x100x107cm	€ 14514	6	0.39	210
Essenza XL high connected	478x100x107cm	€ 14648	6	0.40	213
Essenza XL high connected	488x100x107cm	€ 14744	6	0.40	214
Essenza XL high connected	498x100x107cm	€ 14859	6	0.40	216
Essenza XL high connected	508x100x107cm	€ 14992	6	0.41	218
Essenza XL high connected	518x100x107cm	€ 15101	6	0.42	220

product

1 Essenza

2a Standard

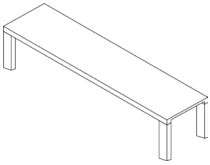

Essenza bench

version	dimensions	oak		smoked oak		walnut	transport information		
		solid	brushed solid	solid	brushed solid	solid	colli	m3	kg
Essenza bench	100x40x45cm	€ 1888	€ 2039	€ 2299	€ 2529	€ 2360	3	0.05	23
Essenza bench	150x40x45cm	€ 2118	€ 2287	€ 2590	€ 2850	€ 2790	3	0.06	29
Essenza bench	180x40x45cm	€ 2354	€ 2541	€ 2886	€ 3171	€ 3068	3	0.07	33
Essenza bench	220x40x45cm	€ 2578	€ 2777	€ 3153	€ 3467	€ 3407	3	0.08	38



Essenza bench cushion

version	dimensions	fabric							transport information		
		fabric group basic	fabric group 1	fabric group 2	fabric group 3	fabric group 4	fabric group 5	COM	colli	m3	kg
Essenza bench cushion	≤ 150 cm	€ 733	€ 769	€ 811	€ 847	€ 902	€ 993	€ 733	1	0.02	2
Essenza bench cushion	151 to 240 cm	€ 781	€ 817	€ 866	€ 896	€ 950	€ 1041	€ 781	1	0.04	2

2b Tailoring

Within the limits indicated on the factsheet: price of the next larger length or width with a surcharge of € 275 (gross incl. VAT). In case of a deviation in both length and width, the next length size is considered first and then the next larger width.

Essenza bench cushion

COM: 1,1 meter gross of plain fabric, minimum width 130 cm.

The Essenza bench cushion is not available in special width.

3 Materials

-

4 Finishes

For an overview of all current Arco colors, please refer to this price list page 5 ff or visit our website www.arco.nl.

5 Additional information

-

product

1 **Essenza**6 **Cable management**

CM04 € 708	CM06 € 545	CM07 € 587	CM15 € 152	CM08 € 97	CM09 € 128	CM12 € 79	CM13 € 97
---------------	---------------	---------------	---------------	--------------	---------------	--------------	--------------

Ordering support

type
size
material table
color table
finish table

example

Essenza rectangular 1
280x90x75cm
solid walnut
1000 - pure
oil

1 **Extend**Arco
Design
Studio

2023

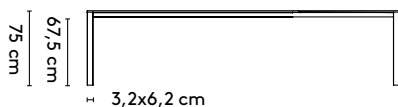
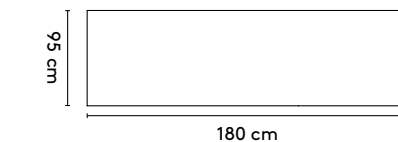
2 **Standard**Extend rectangular 1

180 x 95 x 75 cm
 210 x 95 x 75 cm
 240 x 95 x 75 cm
 280 x 95 x 75 cm

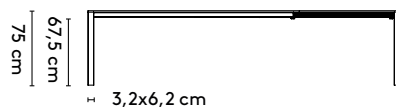
Extend rectangular 2

180 (240) x 95 x 75 cm
 210 (310) x 95 x 75 cm
 240 (340) x 95 x 75 cm

3 **Materials**

Top: oak or walnut (duramas)
Extension leaf: oak or walnut (duramas)
Legs: oak or walnut (veneer)

Materialen

Blad: eiken of noten (duramas)
 Uitschuifblad: eiken of noten (duramas)
 Poten: eiken of noten (fijner)

Materialien

Platte: Eiche oder Nussbaum (Duramas)
 Einlegeplatte: Eiche oder Nussbaum (Duramas)
 Beine: Eiche oder Nussbaum (Furnier)

4 **Finishes**

All Arco colors and finishes for the mentioned materials

Afwerkingen

Alle Arco kleuren en (lak)afwerkingen voor de genoemde materialen

Ausführungen

Alle Arco Farben und Ausführungen für die genannten Materialien

5 **Additional information**

-

Aanvullende informatie

-

Weitere Informationen

-

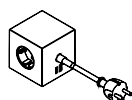
6 **Cable management**

CM16
Avolt Square 1
 7,6 x 7,6 x 7,6 cm

product

1 Extend

2a Standard



Extend rectangular 1

version	dimensions	oak	walnut	transport information		
		duramas	duramas	colli	m3	kg
Extend rectangular 1	180x95x75cm	€ 3721	€ 4217	3	0.17	41
Extend rectangular 1	210x95x75cm	€ 3993	€ 4647	3	0.18	47
Extend rectangular 1	240x95x75cm	€ 4356	€ 5137	3	0.20	52
Extend rectangular 1	280x95x75cm	€ 4393	€ 5173	3	0.23	58



Extend rectangular 2

version	dimensions	oak	walnut	transport information		
		duramas	duramas	colli	m3	kg
Extend rectangular 2	180(240)x95x75cm	€ 4980	€ 5700	4	0.19	61
Extend rectangular 2	210(310)x95x75cm	€ 5663	€ 6534	4	0.20	73
Extend rectangular 2	240(340)x95x75cm	€ 5899	€ 6873	4	0.22	80

3 Materials

-

4 Finishes

For an overview of all current Arco colors, please refer to this price list page 5 ff or visit our website www.arco.nl.

5 Additional information

-

product

1 Extend

6 Cable management

CM16
€ 67

Ordering support

type
size
material top
color top
material legs
color legs
finish table

example

Extend rectangular 2
210 (310) x 95 x 75 cm
oak duramas
1300 - black
oak veneer
1300 - black
P-lacquer

1 Grid

Jonathan Prestwich

2014 - 2016

2a Standard

Grid square

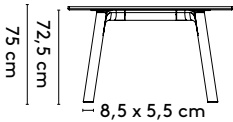
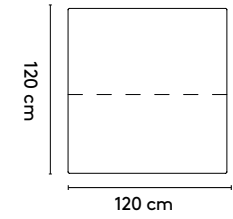

120 x 120 x 75 cm (between legs: 81 cm)
 150 x 150 x 75 cm (between legs: 81 cm)
 180 x 180 x 75 cm (between legs: 106 cm)

Grid round

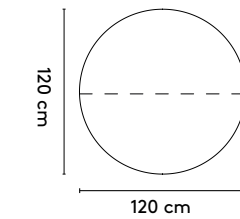

Ø 120 x 75 cm (between legs: 81cm)
 Ø 150 x 75 cm (between legs: 81cm)
 Ø 180 x 75 cm (between legs: 106cm)

Grid rectangular

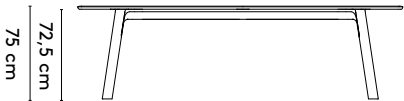
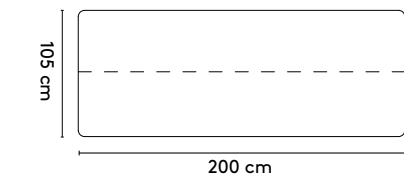

200 x 105/120/160 x 75 cm (between legs: 146cm)
 240 x 105/120/160 x 75 cm (between legs: 176cm)
 280 x 105/120/160 x 75 cm (between legs: 216cm)
 320 x 105/120/160 x 75 cm (between legs: 256cm)
 360 x 105/120/160 x 75 cm (between legs: 296cm)

Grid rectangular connected

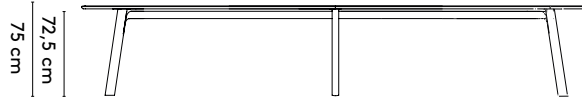
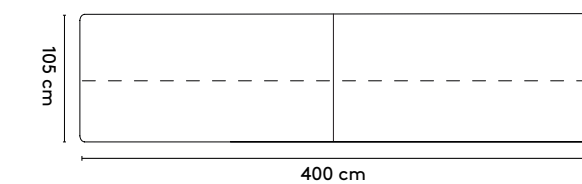

400 x 105/120/160 x 75 cm (between legs: 190 cm)
 480 x 105/120/160 x 75 cm (between legs: 230 cm)
 560 x 105/120/160 x 75 cm (between legs: 270 cm)
 600 x 105/120/160 x 75 cm (between legs: 290 cm)

Grid rectangular high

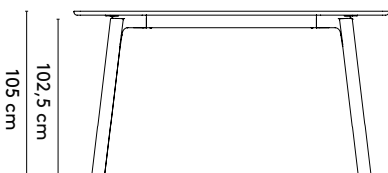
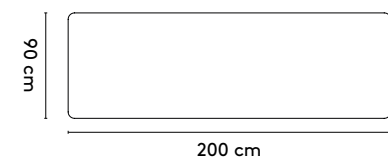

200 x 90/128 x 105 cm (between legs: 160 cm)
 240 x 90/128 x 105 cm (between legs: 200 cm)
 280 x 90/128 x 105 cm (between legs: 240 cm)

Grid rectangular high connected

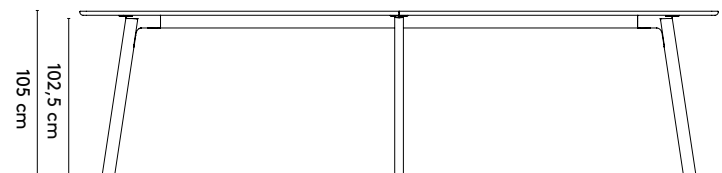
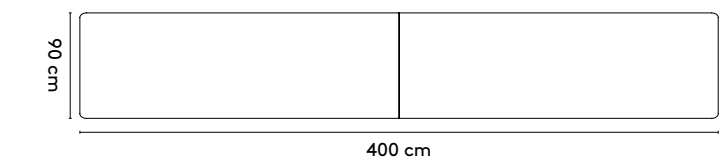

320 x 90/128 x 105 cm (between legs: 117/117 cm)
 360 x 90/128 x 105 cm (between legs: 137/137 cm)
 400 x 90/128 x 105 cm (between legs: 157/157 cm)

1 Grid

2a Standard

Grid barrel

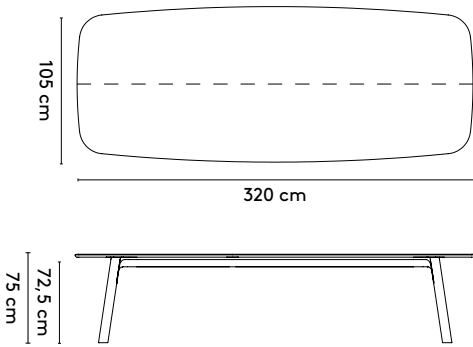

200 x 105/160 x 75 cm (between legs: 146 cm)
 240 x 105/160 x 75 cm (between legs: 178 cm)
 280 x 110/150/160 x 75 cm (between legs: 200 cm)
 320 x 110/150/160 x 75 cm (between legs: 240 cm)
 360 x 110/150/160 x 75 cm (between legs: 280 cm)

Grid barrel connected

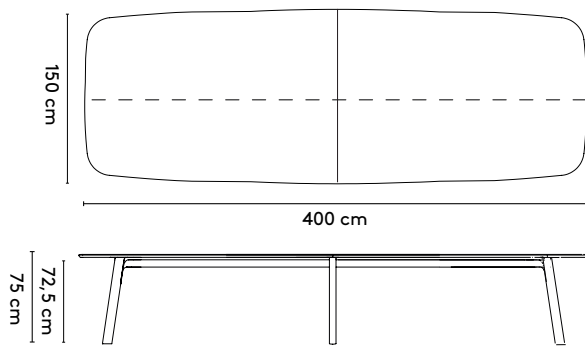

400 x 150/160 x 75 cm (between legs: 165 cm)
 480 x 150/160 x 75 cm (between legs: 197 cm)
 560 x 150/160 x 75 cm (between legs: 237 cm)
 600 x 150/160 x 75 cm (between legs: 257 cm)

please note:

a table top with a width/diameter larger than 128 comes in two parts

a table top with a width wider than 128 cm and length longer than 360 comes in multiple parts

2b Tailoring

Grid square

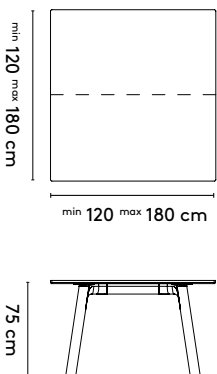

Grid round

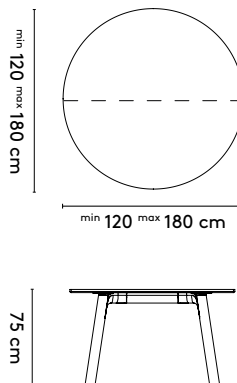

Grid rectangular

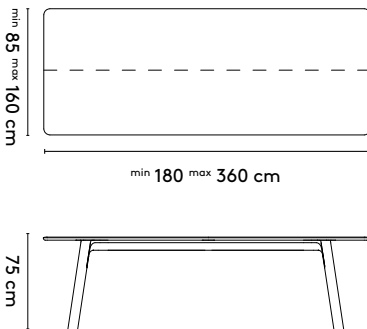

Grid rectangular connected

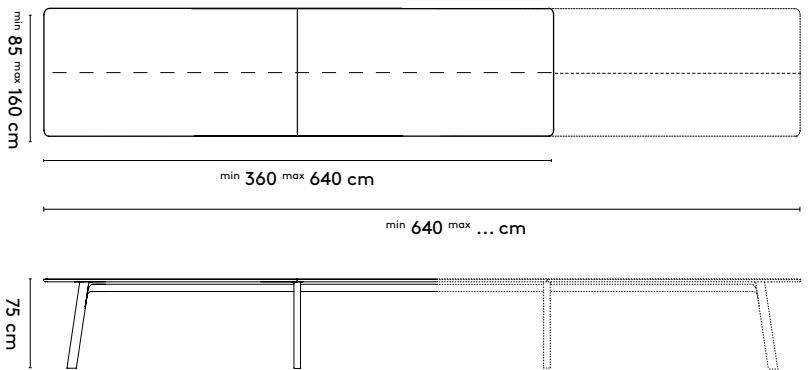

1 Grid

2b Tailoring

Grid rectangular high

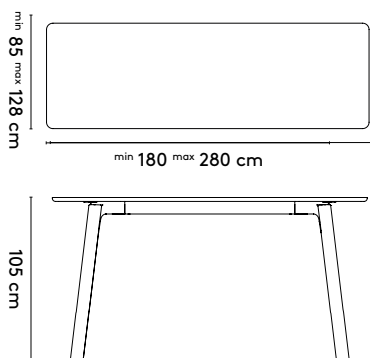

Grid rectangular high

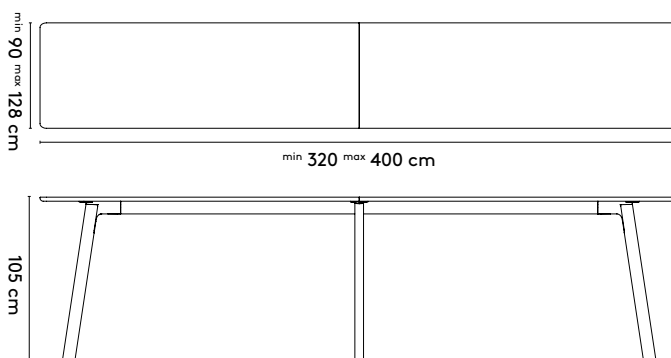

Grid barrel

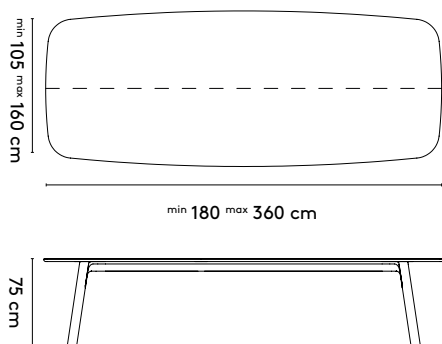

Grid barrel connected

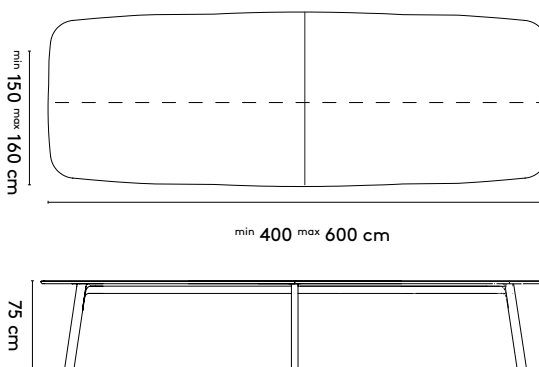

please note:

a table top with a width/diameter larger than 128 comes in two parts

a table top with a width wider than 128 cm and length longer than 360 comes in multiple parts

3 Materials

Top: oak or walnut (solid, veneer), oak smoked (solid)
Frame: epoxy fine texture on aluminum (RAL9010 or RAL9005)
Legs: oak or walnut (solid)

Materialen

Blad: eiken of noten (massief, fineer), gerookt eiken (massief)
Onderstel: epoxy fine texture op aluminium (RAL9010 of RAL9005)
Poten: eiken of noten (massief)

Materialien

Platte: Eiche oder Nussbaum (Massiv, Furnier), Eiche geräuchert (Massiv)
Untergestell: Epoxy fine texture auf Aluminium (RAL9010 oder RAL9005)
Beine: Eiche oder Nussbaum (Massiv)

4 Finishes

All Arco colors and finishes for the mentioned materials

Afwerkingen

Alle Arco kleuren en (lak)afwerkingen voor de genoemde materialen

Ausführungen

Untergestell in einer anderen Farbe Epoxy fine texture (Arco Farbe) möglich

5 Additional information

-

Aanvullende informatie

-

Weitere Informationen

-

6 Cable management

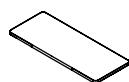

CM04 solid wood
30 x 15 cm

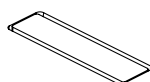

CM05 wood
30 x 10 cm



CM15 EVoline® One spot
Ø 5,9 cm



CM11 cable sock
medium



CM13/CM14 zipper sock
short/long

product

1 **Grid**2a **Standard**Grid square

version	dimensions	oak		smoked oak	walnut		transport information		
		veneer	solid	solid	veneer	solid	colli	m3	kg
Grid square	120x120x75cm	€ 3116	€ 3745	€ 4320	€ 3485	€ 4968	4	0.33	69
Grid square	150x150x75cm	€ 3618	€ 4980	€ 5821	€ 4072	€ 6698	5	0.34	101
Grid square	180x180x75cm	€ 3679	€ 5536	€ 6208	€ 4102	€ 7139	5	0.40	138

Grid round

version	dimensions	oak	smoked oak	walnut	transport information		
		solid	solid	solid	colli	m3	kg
Grid round	120x75cm	€ 3745	€ 4320	€ 4968	4	0.30	58
Grid round	150x75cm	€ 4980	€ 5821	€ 6698	5	0.31	83
Grid round	180x75cm	€ 6171	€ 6922	€ 7968	5	0.37	113

Grid rectangular

version	dimensions	oak		smoked oak	walnut		transport information		
		veneer	solid	solid	veneer	solid	colli	m3	kg
Grid rectangular	200x105x75cm	€ 3836	€ 5591	€ 6795	€ 4435	€ 6958	4	0.38	95
Grid rectangular	200x120x75cm	€ 3945	€ 5990	€ 6982	€ 4562	€ 8035	4	0.43	107
Grid rectangular	200x160x75cm	€ 6135	€ 8906	€ 10769	€ 7200	€ 12397	5	0.43	139
Grid rectangular	240x105x75cm	€ 4072	€ 6099	€ 7581	€ 4701	€ 7515	4	0.41	112
Grid rectangular	240x120x75cm	€ 4217	€ 6395	€ 7720	€ 4871	€ 8561	4	0.49	125
Grid rectangular	240x160x75cm	€ 6643	€ 9402	€ 11266	€ 7732	€ 12947	5	0.49	164
Grid rectangular	280x105x75cm	€ 4701	€ 6595	€ 8380	€ 5433	€ 9632	4	0.45	129
Grid rectangular	280x120x75cm	€ 4871	€ 7061	€ 8967	€ 5627	€ 10298	4	0.55	145
Grid rectangular	280x160x75cm	€ 7139	€ 9904	€ 11744	€ 8259	€ 13510	5	0.56	190
Grid rectangular	320x105x75cm	€ 5028	€ 7103	€ 8852	€ 5815	€ 10177	4	0.49	146
Grid rectangular	320x120x75cm	€ 5234	€ 7575	€ 9814	€ 6044	€ 10945	4	0.62	164
Grid rectangular	320x160x75cm	€ 7636	€ 10376	€ 12542	€ 8779	€ 14049	5	0.62	216
Grid rectangular	360x105x75cm	€ 6075	€ 7599	€ 9324	€ 7176	€ 10721	4	0.53	163
Grid rectangular	360x120x75cm	€ 6371	€ 8126	€ 9977	€ 7539	€ 11471	4	0.67	183
Grid rectangular	360x160x75cm	€ 8132	€ 11036	€ 13044	€ 9305	€ 15004	5	0.70	242

product

1 **Grid**2a **Standard**Grid rectangular connected

version	dimensions	oak		smoked oak	walnut		transport information		
		veneer	solid	solid	veneer	solid	colli	m3	kg
Grid rectangular connected	400x105x75cm	€ 7381	€ 9674	€ 11556	€ 8525	€ 13268	6	0.50	189
Grid rectangular connected	400x120x75cm	€ 7605	€ 11126	€ 13286	€ 8779	€ 15277	6	0.58	211
Grid rectangular connected	400x160x75cm	€ 11580	€ 14393	€ 17164	€ 13559	€ 19736	8	0.59	278
Grid rectangular connected	480x105x75cm	€ 7902	€ 10679	€ 12929	€ 9124	€ 14369	6	0.54	223
Grid rectangular connected	480x120x75cm	€ 8192	€ 12209	€ 14714	€ 9469	€ 16390	6	0.65	249
Grid rectangular connected	480x160x75cm	€ 12572	€ 15386	€ 18598	€ 14605	€ 20831	8	0.67	330
Grid rectangular connected	560x105x75cm	€ 8513	€ 11925	€ 13686	€ 9838	€ 15749	6	0.58	256
Grid rectangular connected	560x120x75cm	€ 8852	€ 13456	€ 15452	€ 10219	€ 17763	6	0.71	288
Grid rectangular connected	560x160x75cm	€ 13831	€ 16638	€ 19306	€ 15930	€ 22198	8	0.74	381
Grid rectangular connected	600x105x75cm	€ 9106	€ 12766	€ 14648	€ 10521	€ 16844	6	0.60	273
Grid rectangular connected	600x120x75cm	€ 9469	€ 14399	€ 16535	€ 10939	€ 19016	6	0.73	307
Grid rectangular connected	600x160x75cm	€ 14805	€ 17806	€ 20661	€ 17043	€ 23747	8	0.77	407

Grid rectangular high

version	dimensions	oak		smoked oak	walnut		transport information		
		veneer	solid	solid	veneer	solid	colli	m3	kg
Grid rectangular high	200x90x105cm	€ 3812	€ 5203	€ 6075	€ 4459	€ 6988	4	0.32	85
Grid rectangular high	200x128x105cm	€ 4471	€ 6262	€ 7932	€ 5234	€ 9142	4	0.44	116
Grid rectangular high	240x90x105cm	€ 4102	€ 5675	€ 6843	€ 4798	€ 7878	4	0.35	100
Grid rectangular high	240x128x105cm	€ 5004	€ 7327	€ 8737	€ 5833	€ 9723	4	0.50	136
Grid rectangular high	280x90x105cm	€ 4381	€ 6135	€ 7775	€ 5131	€ 8954	4	0.38	115
Grid rectangular high	280x128x105cm	€ 5706	€ 8041	€ 10068	€ 6637	€ 11586	4	0.56	156

Grid rectangular high connected

version	dimensions	oak		smoked oak	walnut		transport information		
		veneer	solid	solid	veneer	solid	colli	m3	kg
Grid rectangular high connected	320x90x105cm	€ 5942	€ 7515	€ 8803	€ 6722	€ 9941	6	0.42	140
Grid rectangular high connected	320x128x105cm	€ 7121	€ 10128	€ 11967	€ 8247	€ 13746	6	0.53	187
Grid rectangular high connected	360x90x105cm	€ 6686	€ 8452	€ 9904	€ 7569	€ 11181	6	0.43	155
Grid rectangular high connected	360x128x105cm	€ 8180	€ 11562	€ 13637	€ 9311	€ 15501	6	0.56	208
Grid rectangular high connected	400x90x105cm	€ 7430	€ 9390	€ 11005	€ 8410	€ 12427	6	0.43	169
Grid rectangular high connected	400x128x105cm	€ 8997	€ 12754	€ 15053	€ 10249	€ 17128	6	0.59	228

product

1 **Grid**2a **Standard**Grid barrel

version	dimensions	oak	smoked oak	walnut	transport information		
		solid	solid	solid	colli	m3	kg
Grid barrel	200x105x75cm	€ 5585	€ 7049	€ 7781	4	0.38	92
Grid barrel	200x160x75cm	€ 7738	€ 9735	€ 11181	5	0.43	135
Grid barrel	240x105x75cm	€ 6341	€ 7611	€ 8731	4	0.41	108
Grid barrel	240x160x75cm	€ 9015	€ 10685	€ 12300	5	0.49	159
Grid barrel	280x110x75cm	€ 6849	€ 8616	€ 9898	4	0.46	130
Grid barrel	280x150x75cm	€ 9904	€ 11744	€ 13510	5	0.55	176
Grid barrel	280x160x75cm	€ 9765	€ 11604	€ 13395	5	0.56	186
Grid barrel	320x110x75cm	€ 7345	€ 9094	€ 10449	4	0.50	147
Grid barrel	320x150x75cm	€ 10382	€ 12349	€ 14254	5	0.61	200
Grid barrel	320x160x75cm	€ 10909	€ 12966	€ 14968	5	0.62	211
Grid barrel	360x110x75cm	€ 7853	€ 9572	€ 10987	4	0.54	165
Grid barrel	360x150x75cm	€ 11036	€ 13044	€ 15004	5	0.69	225
Grid barrel	360x160x75cm	€ 11586	€ 13704	€ 15761	5	0.70	238

Grid barrel connected

version	dimensions	oak	smoked oak	walnut	transport information		
		solid	solid	solid	colli	m3	kg
Grid barrel connected	400x150x75cm	€ 13341	€ 16360	€ 18350	8	0.59	258
Grid barrel connected	400x160x75cm	€ 14139	€ 17346	€ 19457	8	0.59	273
Grid barrel connected	480x150x75cm	€ 14393	€ 17164	€ 19736	8	0.66	306
Grid barrel connected	480x160x75cm	€ 14139	€ 17346	€ 19457	8	0.67	323
Grid barrel connected	560x150x75cm	€ 16638	€ 19306	€ 22198	8	0.73	353
Grid barrel connected	560x160x75cm	€ 17642	€ 20468	€ 23529	8	0.74	373
Grid barrel connected	600x150x75cm	€ 17884	€ 20752	€ 23856	8	0.77	377
Grid barrel connected	600x160x75cm	€ 18961	€ 21998	€ 25289	8	0.77	398

product

1 Grid

2b Tailoring

Within the limits indicated on the factsheet: price of the next larger length or width with a surcharge of € 275 (gross incl. VAT). In case of a deviation in both length and width, the next length size is considered first and then the next larger width.

3 Materials

-

4 Finishes

For an overview of all current Arco colors, please refer to this price list page 5 ff or visit our website www.arco.nl.

5 Additional information

-

6 Cable management

CM04	CM05	CM15	CM11	CM13	CM14
€ 708	€ 660	€ 152	€ 67	€ 97	€ 128

Ordering support

	example
type	Grid barrel
size	280x110x75cm
material top	oak solid
color top	1300 - black
material legs	oak solid
color legs	1300 - black
finish table	N-lacquer
color frame	5301 - RAL 9005 black

1 **HAT**

Jorre
van Ast

2022

2 **Standard**

HAT rectangular 1 (powered by cable)

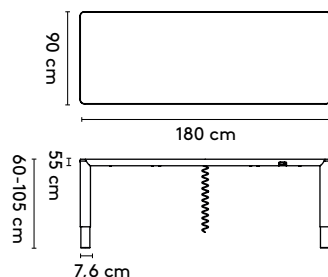

180 x 90 cm
210 x 90 cm
240 x 90/105 cm

HAT rectangular 2 (powered by battery *)

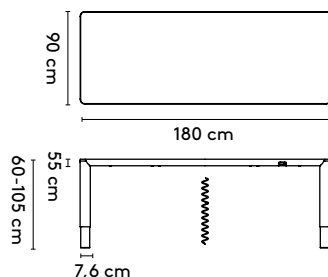

* battery powered version comes with charging cable

180 x 90 cm
210 x 90 cm
240 x 90/105 cm

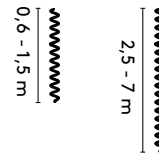

coil cord length long/short
with quickconnect

3 **Materials**

Top: oak (veneer, duramas)
Legs: oak (veneer)

Materialen

Blad: eiken (fineer, duramas)
Onderstel: eiken (fineer)

Materialien

Platte: Eiche (Furnier, Duramas)
Füsse: Eiche (Furnier)

4 **Finishes**

**All Arco colors and finishes for
the mentioned materials**

Afwerkingen

**Alle Arco kleuren en (lak)afwerkingen voor
de genoemde materialen**

Ausführungen

**Alle Arco Farben und Ausführungen für
die genannten Materialien**

5 **Additional information**

Please specify length of charging cable:
**Short charging cable: if the table is above
an electrical point.**
**Long charging cable: if the table is not
above an electric point.**

**Only WCD and USB charger spots are
possible with the HAT.**

Aanvullende informatie

Specificeer lengte van kabel:
**Korte kabel: als de tafel boven een electra
punt staat.**
**Lange kabel: als de tafel niet boven een
vloerpot staat.**

**Alleen WCD en USB charger spots zijn
mogelijk bij de HAT.**

Weitere Informationen

Bitte spezifizieren Sie die Länge des Kabels:
**Kurzes Kabel: wenn der Tisch über einem
elektrischen Anschluss steht.**
**Langes Kabel: wenn der Tisch nicht über
einem elektrischen Anschluss steht.**

**Es gibt nur WCD- und USB-Ladestationen
mit dem HAT möglich.**

6 **Cable management**

CM15
EVOLINE® One spot
Ø 5,9 cm

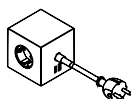

CM16
Avolt Square 1
7,6 x 7,6 x 7,6 cm

product

1 **HAT**2a **Standard**

HAT rectangular 1

version	dimensions	oak		transport information		
		veneer	duramas	colli	m3	kg
HAT rectangular 1	180x90x75cm	€ 8228	€ 8483	2	1.29	86
HAT rectangular 1	210x90x75cm	€ 8585	€ 8791	2	0.44	94
HAT rectangular 1	240x90x75cm	€ 8791	€ 9106	2	0.46	102
HAT rectangular 1	240x105x75cm	€ 9184	€ 9420	2	0.48	111



HAT rectangular 2

version	dimensions	oak		transport information		
		veneer	duramas	colli	m3	kg
HAT rectangular 2	180x90x75cm	€ 9160	€ 9414	2	0.42	87
HAT rectangular 2	210x90x75cm	€ 9517	€ 9674	2	0.44	95
HAT rectangular 2	240x90x75cm	€ 9723	€ 10031	2	0.46	102
HAT rectangular 2	240x105x75cm	€ 10122	€ 10346	2	0.48	112

3 **Materials**

-

4 **Finishes**

For an overview of all current Arco colors, please refer to this price list page 5 ff or visit our website www.arco.nl.

5 **Additional information**

-

6 **Cable management**

CM15
€ 152

CM16
€ 67

Ordering support

example

type
size
material top
color top
material legs
color legs
finish table
length cable

HAT rectangular 1
210x90x75cm
oak duramas
1300 - black
oak veneer
1300 - black
P-lacquer
short

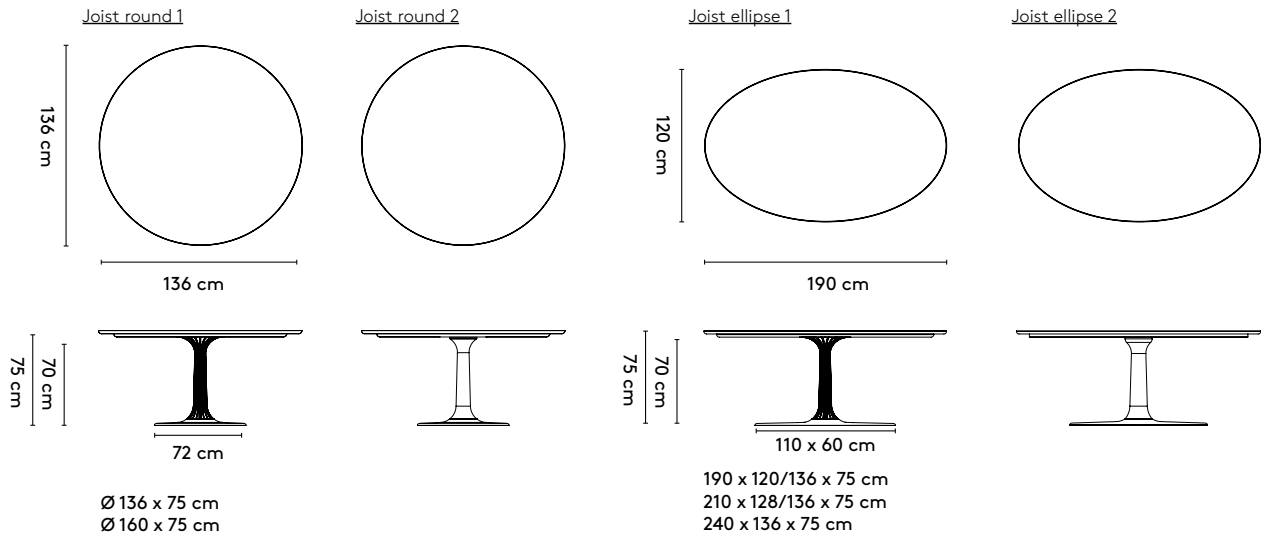
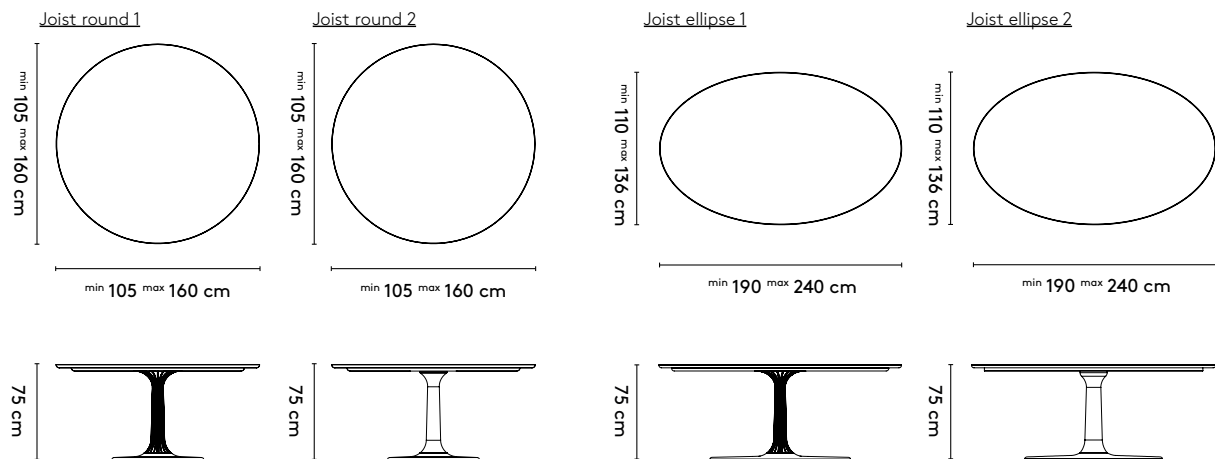
1 **Joist****Jorre
van Ast****2019**2a **Standard**2b **Tailoring**3 **Materials**

Top: oak or walnut (solid), oak smoked (solid)
Column: epoxy fine texture on aluminum (Joist 1), oak or walnut (solid), oak smoked (solid) (Joist 2)
Base: epoxy fine texture on aluminum

Materialen

Blad: eiken of noten (massief), gerookt eiken (massief)
 Kolom: epoxy fine texture op aluminium (Joist 1), eiken of noten (massief), gerookt eiken (massief) (Joist 2)
 Voet: epoxy fine texture op aluminium

Materialien

Platte: Eiche oder Nussbaum (Massiv), Eiche geräuchert (Massiv)
 Säule: Epoxy fine texture auf Aluminium (Joist 1), Eiche oder Nussbaum (Massiv), Eiche geräuchert (Massiv) (Joist 2)
 Fuss: epoxy fine texture auf Aluminium

4 **Finishes**

All Arco colors and finishes for the mentioned materials

Afwerkingen

Alle Arco kleuren en (lak)afwerkingen voor de genoemde materialen

Ausführungen

Alle Arco Farben und Ausführungen für die genannten Materialien

5 **Additional information**

-

Aanvullende informatie

-

Weitere Informationen

-

6 **Cable management**

-

product

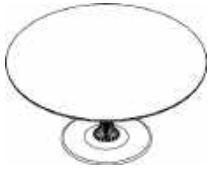
1 **Joist**2a **Standard**Joist round 1

version	dimensions	wood			transport information		
		oak	smoked oak	walnut	colli	m3	kg
Joist round 1	136x75cm	€ 4822	€ 5821	€ 5706	4	0.39	74
Joist round 1	160x75cm	€ 5748	€ 6722	€ 7049	4	0.55	84

Joist round 2

version	dimensions	wood			transport information		
		oak	smoked oak	walnut	colli	m3	kg
Joist round 2	136x75cm	€ 4822	€ 5821	€ 5706	3	2.03	73
Joist round 2	160x75cm	€ 5748	€ 6722	€ 7049	3	2.19	83

Joist ellipse 1

version	dimensions	oak		smoked oak		walnut	transport information		
		solid	brushed solid	solid	brushed solid		colli	m3	kg
Joist ellipse 1	190x120x75cm	€ 5530	€ 5960	€ 6885	€ 7430	€ 7424	4	0.49	102
Joist ellipse 1	190x136x75cm	€ 6020		€ 7496		€ 7751	4	0.54	109
Joist ellipse 1	210x128x75cm	€ 6141	€ 6631	€ 7660	€ 8271	€ 8277	4	0.57	113
Joist ellipse 1	210x136x75cm	€ 6353		€ 7926		€ 8549	4	0.60	117
Joist ellipse 1	240x136x75cm	€ 6668		€ 8337		€ 8991	4	0.68	127

Joist ellipse 2

version	dimensions	oak		smoked oak		walnut	transport information		
		solid	brushed solid	solid	brushed solid		colli	m3	kg
Joist ellipse 2	190x120x75cm	€ 5530	€ 5960	€ 6885	€ 7430	€ 7424	3	2.13	104
Joist ellipse 2	190x136x75cm	€ 6020		€ 7496		€ 7751	3	2.18	112
Joist ellipse 2	210x128x75cm	€ 6141	€ 6631	€ 7660	€ 8271	€ 8277	3	2.21	116
Joist ellipse 2	210x136x75cm	€ 6353		€ 7926		€ 8549	3	2.24	120
Joist ellipse 2	240x136x75cm	€ 6668		€ 8337		€ 8991	3	2.32	129

product

1 Joist

2b Tailoring

Within the limits indicated on the factsheet: price of the next larger length or width with a surcharge of € 275 (gross incl. VAT). In case of a deviation in both length and width, the next length size is considered first and then the next larger width.

3 Materials

-

4 Finishes

For an overview of all current Arco colors, please refer to this price list page 5 ff or visit our website www.arco.nl.

5 Additional information

-

6 Cable management

-

Ordering support

example

type	Joist round 2
size	Ø136x75cm
color top	1201 - oak smoke
finish top	N-lacquer
color column	1201 - oak smoke
finish column	N-lacquer
color laquer base plate	5301 - RAL9005 black

1 **Kami**

**Joost
van der Vecht**

2020 - 2023

2a **Standard**

Kami Oval 1

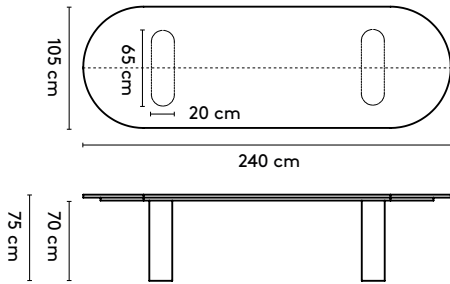

- 240 x 105/120/150 x 75 cm (2 columns, between columns: 115/100/70 cm)
- 280 x 105/120/150 x 75 cm (2 columns, between columns: 155/140/110 cm)
- 320 x 105/120/150 x 75 cm (2 columns, between columns: 178/178/150 cm)
- 360 x 105/120/150 x 75 cm (2 columns, between columns: 178/178/178 cm)

Kami Oval 1 connected

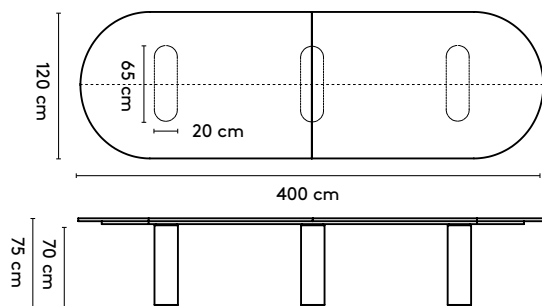

- 400 x 120/150 x 75 cm (3 columns, between columns: 105/105 cm)
- 440 x 120/150 x 75 cm (3 columns, between columns: 125/125 cm)
- 480 x 120/150 x 75 cm (3 columns, between columns: 145/145 cm)
- 520 x 120/150 x 75 cm (4 columns, between columns: 103/103 cm)
- 560 x 120/150 x 75 cm (4 columns, between columns: 117/117 cm)
- 600 x 120/150 x 75 cm (4 columns, between columns: 130/130 cm)
- 640 x 120/150 x 75 cm (4 columns, between columns: 143/143 cm)
- 680 x 120/150 x 75 cm (5 columns, between columns: 112,5/112,5 cm)
- 720 x 120/150 x 75 cm (5 columns, between columns: 122,5/122,5 cm)

Kami Oval 2

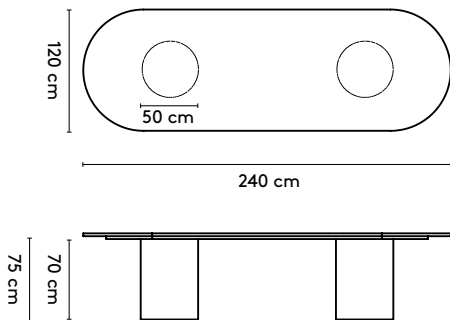

- 240 x 120 x 75 cm (2 columns, between columns: 70 cm)
- 280 x 120 x 75 cm (2 columns, between columns: 110 cm)
- 320 x 120 x 75 cm (2 columns, between columns: 148 cm)
- 360 x 120 x 75 cm (2 columns, between columns: 148 cm)

Kami Oval 2 Connected

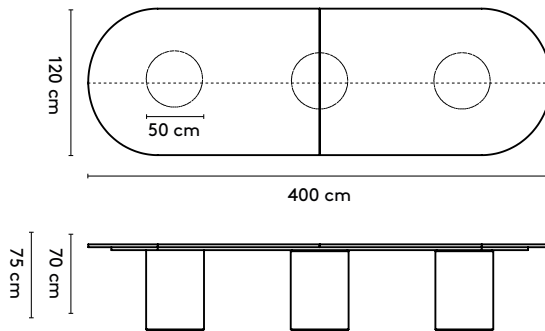

- 400 x 120/150 x 75 cm (3 columns, between columns: 75/75 cm)
- 440 x 120/150 x 75 cm (3 columns, between columns: 95/95 cm)
- 480 x 120/150 x 75 cm (3 columns, between columns: 115/115 cm)
- 520 x 120/150 x 75 cm (4 columns, between columns: 73/73 cm)
- 560 x 120/150 x 75 cm (4 columns, between columns: 87/87 cm)
- 600 x 120/150 x 75 cm (4 columns, between columns: 100/100 cm)
- 640 x 120/150 x 75 cm (4 columns, between columns: 113/113 cm)
- 680 x 120/150 x 75 cm (5 columns, between columns: 82,5/82,5 cm)
- 720 x 120/150 x 75 cm (5 columns, between columns: 92,5/92,5 cm)

Kami Round

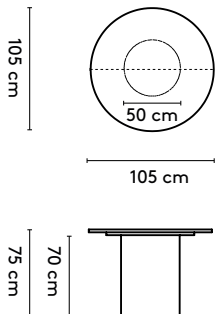

- ∅ 105 x 75 cm (1 column)
- ∅ 120 x 75 cm (1 column)
- ∅ 128 x 75 cm (1 column)
- ∅ 140 x 75 cm (1 column)
- ∅ 150 x 75 cm (1 column)

1 Kami

2a **Standard**

Kami Oval 3

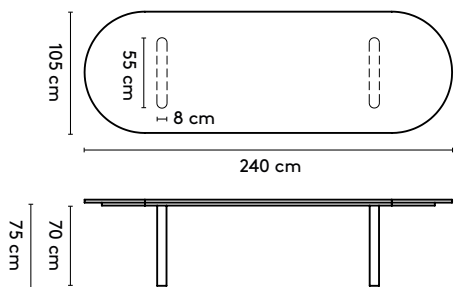

- 210 x 90/105/120 x 75 cm (2 columns, between columns: 112/97 cm)
- 240 x 90/105/120 x 75 cm (2 columns, between columns: 142/127/112 cm)
- 280 x 90/105/120 x 75 cm (2 columns, between columns: 182/167/152 cm)
- 320 x 90/105/120 x 75 cm (2 columns, between columns: 190/190/190 cm)
- 360 x 105/120 x 75 cm (2 columns, between columns: 190/190 cm)

Kami Oval 3 connected

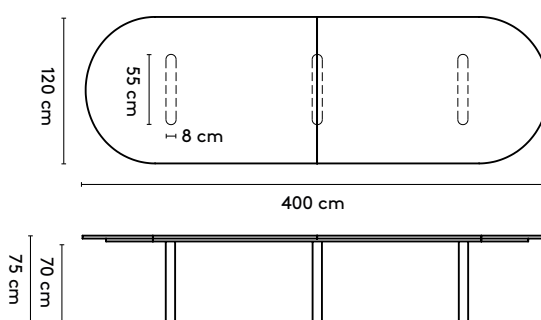

- 400 x 120 x 75 cm (3 columns, between columns: 117/117 cm)
- 440 x 120 x 75 cm (3 columns, between columns: 137/137 cm)
- 480 x 120 x 75 cm (3 columns, between columns: 157/157 cm)
- 520 x 120 x 75 cm (4 columns, between columns: 115/115 cm)
- 560 x 120 x 75 cm (4 columns, between columns: 129/129 cm)
- 600 x 120 x 75 cm (4 columns, between columns: 142/142 cm)
- 640 x 120 x 75 cm (4 columns, between columns: 155/155 cm)
- 680 x 120 x 75 cm (5 columns, between columns: 124,5/124,5 cm)
- 720 x 120 x 75 cm (5 columns, between columns: 134,5/134,5 cm)

please note:

- a Kami Round table top with a diameter larger than 128 comes in two parts
- a table top with a width wider than 128 cm and length longer than 360 comes in multiple parts

1 Kami

2b Tailoring

Kami Oval 1

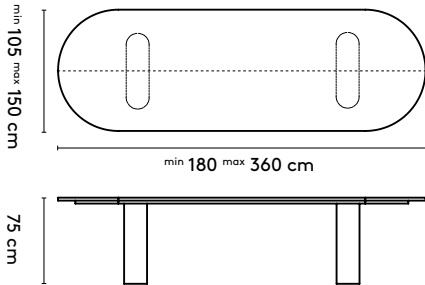

Kami Oval 1 connected

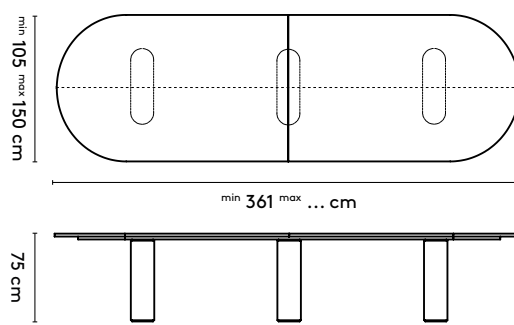

Kami Oval 2

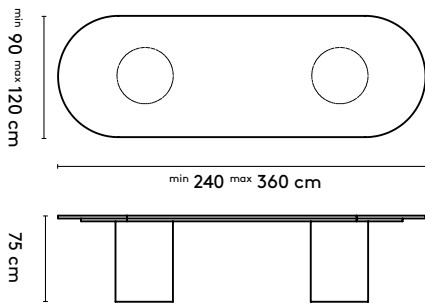

Kami Oval 2 Connected

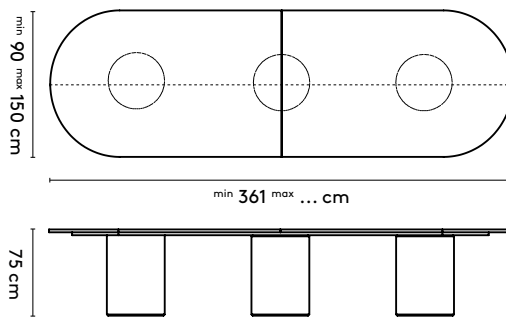

Kami Round

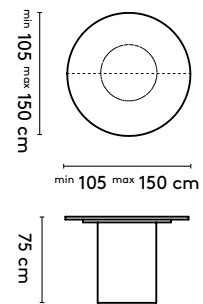

Kami Oval 3

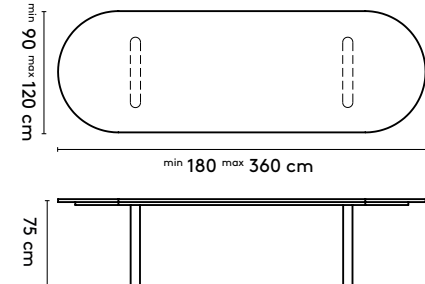

Kami Oval 3 connected

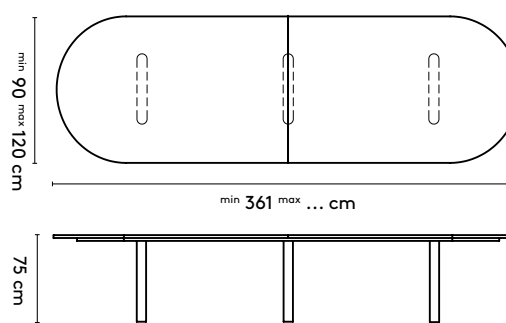

please note:
 a Kami Round table top with a diameter larger than 128 comes in two parts
 a table top with a width wider than 128 cm and length longer than 360 comes in multiple parts

<p>3 Materials</p> <p>Top: oak or walnut (solid, veneer), oak smoked (solid) Column: oak or walnut (veneer)</p>	<p>3 Materialen</p> <p>Blad: eiken of noten (massief, fineer), eiken gerookt (massief) Kolom: eiken of noten (fineer)</p>	<p>3 Materialien</p> <p>Platte: Eiche oder Nussbaum (Massiv, Furnier), Eiche geräuchert (Massiv) Säule: Eiche oder Nussbaum (Furnier)</p>
<p>4 Finishes</p> <p>All Arco colors and finishes for the mentioned materials</p>	<p>4 Afwerkingen</p> <p>Alle Arco kleuren en (lak)afwerkingen voor de genoemde materialen</p>	<p>4 Ausführungen</p> <p>Alle Arco Farben und Ausführungen für die genannten Materialien</p>
<p>5 Additional information</p> <p>Kami Round from 120 cm is supplied with a counterweight in the column</p>	<p>5 Aanvullende informatie</p> <p>Kami Round vanaf 120 cm wordt met een conragewicht in de kolom geleverd</p>	<p>5 Weitere Informationen</p> <p>Kami Round ab 120 cm wird mit eine Gegengewicht in der Säule geliefert</p>

6 Cable management

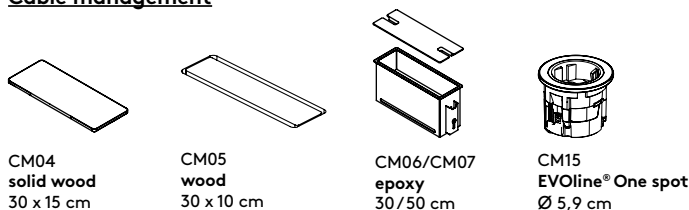

product

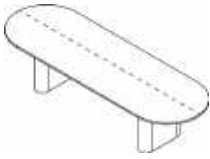
1 **Kami**2a **Standard**Kami Oval 1

version	dimensions	oak			smoked oak		walnut		transport information		
		veneer	solid	brushed solid	solid	brushed solid	veneer	solid	colli	m3	kg
Kami Oval 1	240x105x75cm	€ 5615	€ 6468	€ 6770	€ 7061	€ 7363	€ 5978	€ 7684	5	0.83	152
Kami Oval 1	240x120x75cm	€ 5966	€ 7012	€ 7381	€ 7636	€ 8059	€ 6407	€ 8404	5	0.87	159
Kami Oval 1	240x150x75cm	€ 7533	€ 8549		€ 9771		€ 8095	€ 10751	6	0.95	191
Kami Oval 1	280x105x75cm	€ 6087	€ 7061	€ 7424	€ 7787	€ 8144	€ 6498	€ 8489	5	0.88	176
Kami Oval 1	280x120x75cm	€ 6504	€ 7720	€ 8107	€ 8470	€ 8876	€ 7000	€ 9317	5	0.93	185
Kami Oval 1	280x150x75cm	€ 8265	€ 9523		€ 10969		€ 8900	€ 12058	6	1.03	225
Kami Oval 1	320x105x75cm	€ 6504	€ 7672	€ 8095	€ 8513	€ 8924	€ 6988	€ 9275	5	0.93	200
Kami Oval 1	320x120x75cm	€ 7103	€ 8416	€ 8894	€ 9305	€ 9765	€ 7575	€ 10231	5	0.99	211
Kami Oval 1	320x150x75cm	€ 9069	€ 10491		€ 12149		€ 9777	€ 13365	6	1.10	258
Kami Oval 1	360x105x75cm	€ 6964	€ 8277	€ 8755	€ 9251	€ 9723	€ 7496	€ 10080	5	0.98	224
Kami Oval 1	360x120x75cm	€ 7575	€ 9118	€ 9717	€ 10140	€ 10661	€ 8150	€ 11157	5	1.04	237
Kami Oval 1	360x150x75cm	€ 9880	€ 11459		€ 13347		€ 10636	€ 14672	6	1.18	292

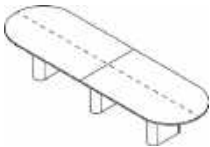
Kami Oval 1 Connected

version	dimensions	oak			smoked oak		walnut		transport information		
		veneer	solid	brushed solid	solid	brushed solid	veneer	solid	colli	m3	kg
Kami Oval 1 Connected	400x120x75cm	€ 9771	€ 11350	€ 11949	€ 12845	€ 12990	€ 10497	€ 13649	8	1.70	276
Kami Oval 1 Connected	400x150x75cm	€ 12149	€ 13801		€ 15858		€ 13068	€ 17443	10	1.85	339
Kami Oval 1 Connected	440x120x75cm	€ 10310	€ 12052	€ 12712	€ 13244	€ 13885	€ 11084	€ 14581	8	1.77	302
Kami Oval 1 Connected	440x150x75cm	€ 12881	€ 14732		€ 17007		€ 13740	€ 18707	10	1.93	372
Kami Oval 1 Connected	480x120x75cm	€ 10848	€ 12748	€ 13462	€ 14079	€ 14775	€ 11671	€ 15482	8	1.83	328
Kami Oval 1 Connected	480x150x75cm	€ 13619	€ 15979		€ 18150		€ 14520	€ 19965	10	2.01	406
Kami Oval 1 Connected	520x120x75cm	€ 11604	€ 13964	€ 14769	€ 15065	€ 15827	€ 12482	€ 16408	10	2.73	367
Kami Oval 1 Connected	520x150x75cm	€ 14508	€ 17255		€ 19300		€ 15616	€ 21236	12	2.91	452
Kami Oval 1 Connected	560x120x75cm	€ 12264	€ 14660	€ 15525	€ 15718	€ 16529	€ 13171	€ 17074	10	2.79	393
Kami Oval 1 Connected	560x150x75cm	€ 15156	€ 17933		€ 19947		€ 16299	€ 21914	12	2.99	486
Kami Oval 1 Connected	600x120x75cm	€ 12917	€ 15343	€ 16281	€ 16372	€ 17243	€ 13716	€ 17763	10	2.85	419
Kami Oval 1 Connected	600x150x75cm	€ 15803	€ 18592		€ 20806		€ 16977	€ 22591	12	3.06	519
Kami Oval 1 Connected	640x120x75cm	€ 13431	€ 16051	€ 17043	€ 17019	€ 17963	€ 14406	€ 18441	10	2.91	445
Kami Oval 1 Connected	640x150x75cm	€ 16456	€ 19270		€ 21460		€ 17673	€ 23269	12	3.14	553
Kami Oval 1 Connected	680x120x75cm	€ 14218	€ 17055	€ 18114	€ 17679	€ 18671	€ 15228	€ 19112	12	4.04	484
Kami Oval 1 Connected	680x150x75cm	€ 17267	€ 20691		€ 22107		€ 18526	€ 23940	14	4.30	600
Kami Oval 1 Connected	720x120x75cm	€ 14883	€ 17751	€ 18895	€ 18332	€ 19385	€ 15912	€ 19790	12	4.10	510
Kami Oval 1 Connected	720x150x75cm	€ 17921	€ 21381		€ 22767		€ 19203	€ 24618	14	4.37	634

product

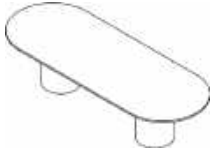
1 **Kami**2a **Standard**Kami Oval 2

version	dimensions	oak			smoked oak		walnut		transport information		
		veneer	solid	brushed solid	solid	brushed solid	veneer	solid	colli	m3	kg
Kami Oval 2	240x120x75cm	€ 5694	€ 6734	€ 7091	€ 7369	€ 7720	€ 6135	€ 8107	5	1.75	160
Kami Oval 2	280x120x75cm	€ 6238	€ 7442	€ 8071	€ 8216	€ 8616	€ 6716	€ 9027	5	1.81	186
Kami Oval 2	320x120x75cm	€ 6770	€ 8126	€ 8604	€ 9051	€ 9517	€ 7297	€ 9947	5	1.87	212
Kami Oval 2	360x120x75cm	€ 7309	€ 8840	€ 9378	€ 9886	€ 10406	€ 7872	€ 10872	5	1.92	238

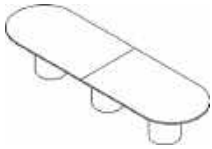
Kami Oval 2 Connected

version	dimensions	oak			smoked oak		walnut		transport information		
		veneer	solid	brushed solid	solid	brushed solid	veneer	solid	colli	m3	kg
Kami Oval 2 Connected	400x120x75cm	€ 9372	€ 10927	€ 11526	€ 12022	€ 12597	€ 10086	€ 13238	8	3.68	278
Kami Oval 2 Connected	400x150x75cm	€ 11683	€ 13341		€ 15386		€ 12476	€ 17019	10	3.83	340
Kami Oval 2 Connected	440x120x75cm	€ 9916	€ 11429	€ 12064	€ 12863	€ 13492	€ 10673	€ 14145	8	3.75	303
Kami Oval 2 Connected	440x150x75cm	€ 12294	€ 14266		€ 16535		€ 13268	€ 18278	10	3.91	374
Kami Oval 2 Connected	480x120x75cm	€ 10455	€ 12349	€ 13062	€ 13577	€ 14266	€ 11247	€ 14938	8	3.81	330
Kami Oval 2 Connected	480x150x75cm	€ 13020	€ 15204		€ 17685		€ 14061	€ 19542	10	3.99	408
Kami Oval 2 Connected	520x120x75cm	€ 11211	€ 13552	€ 14357	€ 14678	€ 15434	€ 11955	€ 15985	10	6.25	369
Kami Oval 2 Connected	520x150x75cm	€ 14043	€ 16777		€ 18834		€ 15150	€ 20806	12	6.43	455
Kami Oval 2 Connected	560x120x75cm	€ 11744	€ 14242	€ 15107	€ 15301	€ 16118	€ 12627	€ 16674	10	6.31	395
Kami Oval 2 Connected	560x150x75cm	€ 14684	€ 17455		€ 19481		€ 15833	€ 21490	12	6.51	488
Kami Oval 2 Connected	600x120x75cm	€ 12397	€ 14932	€ 15864	€ 15954	€ 16832	€ 13310	€ 17334	10	6.37	421
Kami Oval 2 Connected	600x150x75cm	€ 15337	€ 18108		€ 20135		€ 16505	€ 22162	12	6.58	522
Kami Oval 2 Connected	640x120x75cm	€ 13044	€ 15053	€ 16009	€ 16614	€ 17545	€ 13982	€ 18017	10	6.43	447
Kami Oval 2 Connected	640x150x75cm	€ 15991	€ 18786		€ 20776		€ 17195	€ 22833	12	6.66	555
Kami Oval 2 Connected	680x120x75cm	€ 13831	€ 16323	€ 17376	€ 17261	€ 18247	€ 14817	€ 18695	12	9.54	487
Kami Oval 2 Connected	680x150x75cm	€ 16789	€ 20189		€ 21635		€ 17866	€ 23511	14	9.80	603
Kami Oval 2 Connected	720x120x75cm	€ 14472	€ 17013	€ 18132	€ 17908	€ 18967	€ 15501	€ 19373	12	9.60	513
Kami Oval 2 Connected	720x150x75cm	€ 17449	€ 20885		€ 22289		€ 18544	€ 24194	14	9.87	637

product

1 **Kami**2a **Standard**Kami Round

version	dimensions	oak			smoked oak		walnut		transport information		
		veneer	solid	brushed solid	solid	brushed solid	veneer	solid	colli	m3	kg
Kami Round	105x75cm	€ 2584	€ 2917	€ 3056	€ 3249	€ 3376	€ 2644	€ 3334	4	0.50	59
Kami Round	120x75cm	€ 2850	€ 3413	€ 3570	€ 3733	€ 3872	€ 3068	€ 3981	4	0.55	128
Kami Round	128x75cm	€ 3340	€ 4223	€ 4459	€ 4429	€ 4665	€ 3485	€ 4937	4	0.57	137
Kami Round	140x75cm	€ 4018	€ 4943		€ 5197		€ 4193	€ 5802	5	0.61	165
Kami Round	150x75cm	€ 4459	€ 5512		€ 5796		€ 4653	€ 6504	5	0.65	208

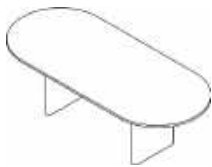
Kami Oval 3

version	dimensions	oak			smoked oak		walnut		transport information		
		veneer	solid	brushed solid	solid	brushed solid	veneer	solid	colli	m3	kg
Kami Oval 3	210x90x75cm	€ 4943	€ 5464	€ 5687	€ 5990	€ 6202	€ 5113	€ 6141	5	0.75	109
Kami Oval 3	210x105x75cm	€ 5203	€ 5845	€ 6111	€ 6456	€ 6716	€ 5379	€ 6643	5	0.79	125
Kami Oval 3	210x120x75cm	€ 5409	€ 6311	€ 6601	€ 6970	€ 7248	€ 5808	€ 7176	5	0.83	130
Kami Oval 3	240x90x75cm	€ 5076	€ 5851	€ 6105	€ 6226	€ 6468	€ 5445	€ 6631	5	0.77	124
Kami Oval 3	240x105x75cm	€ 5560	€ 6280	€ 6589	€ 7006	€ 7303	€ 5760	€ 7212	5	0.83	143
Kami Oval 3	240x120x75cm	€ 5748	€ 6825	€ 7176	€ 7363	€ 7702	€ 6184	€ 7884	5	0.87	150
Kami Oval 3	280x90x75cm	€ 5476	€ 6365	€ 6662	€ 6837	€ 7127	€ 5899	€ 7291	5	0.83	145
Kami Oval 3	280x105x75cm	€ 5815	€ 6873	€ 7230	€ 7732	€ 8089	€ 6256	€ 7968	5	0.88	167
Kami Oval 3	280x120x75cm	€ 6274	€ 7509	€ 7890	€ 8180	€ 8579	€ 6625	€ 8749	5	0.93	176
Kami Oval 3	320x90x75cm	€ 5887	€ 6897	€ 7236	€ 7454	€ 7775	€ 6329	€ 7938	5	0.87	165
Kami Oval 3	320x105x75cm	€ 6262	€ 7466	€ 7878	€ 8452	€ 8864	€ 6746	€ 8712	5	0.93	191
Kami Oval 3	320x120x75cm	€ 6849	€ 8198	€ 8664	€ 8985	€ 9445	€ 7176	€ 9608	5	0.99	202
Kami Oval 3	360x105x75cm	€ 6716	€ 8071	€ 8519	€ 8858	€ 9299	€ 7230	€ 9469	5	0.98	215
Kami Oval 3	360x120x75cm	€ 7315	€ 8882	€ 9293	€ 9801	€ 10310	€ 7720	€ 10485	5	1.04	228

product

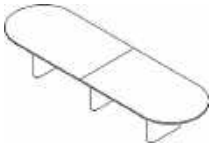
1 **Kami**2a **Standard**

Kami Oval 3 connected

version	dimensions	oak			smoked oak		walnut		transport information		
		veneer	solid	brushed solid	solid	brushed solid	veneer	solid	colli	m3	kg
Kami Oval 3 connected	400x120x75cm	€ 9445	€ 11072	€ 11659	€ 12433	€ 12578	€ 9965	€ 12839	8	1.70	262
Kami Oval 3 connected	440x120x75cm	€ 9777	€ 11332	€ 12409	€ 12820	€ 13444	€ 10310	€ 13716	8	1.77	288
Kami Oval 3 connected	480x120x75cm	€ 10292	€ 12445	€ 13141	€ 13631	€ 14309	€ 10860	€ 14569	8	1.83	314
Kami Oval 3 connected	520x120x75cm	€ 11544	€ 13371	€ 14145	€ 14998	€ 15767	€ 11955	€ 15440	10	2.73	349
Kami Oval 3 connected	560x120x75cm	€ 12203	€ 14043	€ 14877	€ 15652	€ 16469	€ 12627	€ 16069	10	2.79	375
Kami Oval 3 connected	600x120x75cm	€ 12373	€ 14702	€ 15597	€ 16305	€ 17176	€ 13286	€ 16717	10	2.85	401
Kami Oval 3 connected	640x120x75cm	€ 13008	€ 15089	€ 16027	€ 16953	€ 17890	€ 13952	€ 17358	10	2.91	427
Kami Oval 3 connected	680x120x75cm	€ 14157	€ 16033	€ 17043	€ 17939	€ 18943	€ 15162	€ 17993	12	4.04	462
Kami Oval 3 connected	720x120x75cm	€ 14817	€ 16705	€ 17769	€ 18598	€ 19675	€ 15851	€ 18628	12	4.10	488

2b **Tailoring**

Within the limits indicated on the factsheet: price of the next larger length or width with a surcharge of € 275 (gross incl. VAT). In case of a deviation in both length and width, the next length size is considered first and then the next larger width.

3 **Materials**

-

4 **Finishes**

For an overview of all current Arco colors, please refer to this price list page 5 ff or visit our website www.arco.nl.

5 **Additional information**

-

6 **Cable management**

CM04	CM05	CM06	CM07	CM15
€ 708	€ 660	€ 545	€ 587	€ 152

Ordering support

example

type	Kami oval 1
size	360x120x75cm
material top	oak veneer
color top	1100 - natural
material column	oak veneer
color legs	1100 - natural
finish table	N-lacquer

1 **Move****Hofman-
Dujardin**

2022

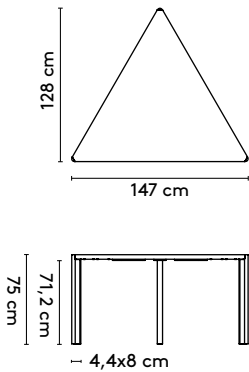
2 **Standard**Move triangular 1

147 x 128 x 75 cm

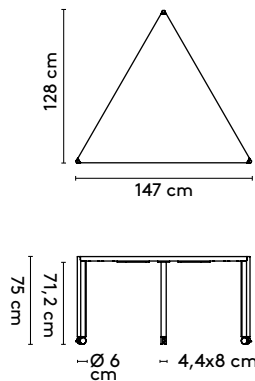
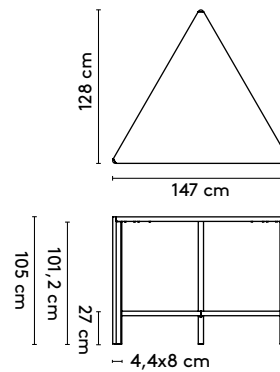
Move triangular 2Move triangular high 1

147 x 128 x 105 cm

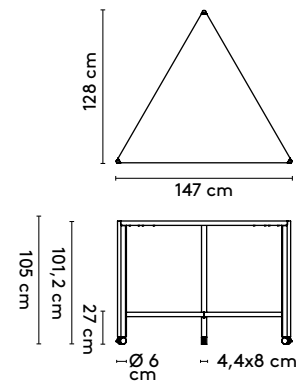
Move triangular high 23 **Materials**

Top: oak or walnut (veneer, duramas), Fenix® HPL
Legs: oak or walnut (solid)
Footrest: epoxy fine texture on aluminum (black or grey)

Materialen

Blad: eiken of noten (fineer, duramas), Fenix® HPL
Onderstel: eiken of noten (massief)
Voetensteun: epoxy fine texture op aluminium (black of grey)

Materialien

Platte: Eiche oder Nussbaum (Furnier, Duramas), Fenix® HPL
Füsse: Eiche oder Nussbaum (Massiv)
Fußstütze: Epoxy fine texture auf Aluminium (black oder grey)

4 **Finishes**

All Arco colors and finishes for the mentioned materials

Afwerkingen

Alle Arco kleuren en (lak)afwerkingen voor de genoemde materialen

Ausführungen

Alle Arco Farben und Ausführungen für die genannten Materialien

5 **Additional information**

The Move 2 is equipped with castors with brakes and comes with invisible magnets for easy configuration

The Move triangular 1 and Move triangular 2 are stackable. It is possible to stack these tables up to a maximum of six pieces

Depending on the configuration of the Move table, multiple legs can converge in one place. Furthermore, we cannot guarantee that every leg is 100% perpendicular. Small deviations are part of any handcrafted product. For this reason, each leg turns slightly inward. The flatness (or otherwise) of the floor may also play a role in perceived deviations

Aanvullende informatie

De Move 2 is voorzien van wielen met rem en wordt geleverd met onzichtbare magneten voor eenvoudige configuratie

De Move triangular 1 en Move triangular 2 zijn stapelbaar. Het is mogelijk deze tafels te stapelen tot een maximum van zes stuks

Bij de Move tafel komen afhankelijk van de configuratie veel poten bij elkaar op één plek. Wij kunnen niet garanderen dat alle poten van de Move tafels altijd 100% haaks staan. Kleine toleranties zijn onderdeel van het product. Om die reden is de positie van de poot iets naar binnen gezet. Tevens worden de tafels op verschillende manier gecombineerd waardoor eventuele verschillen elkaar de ene keer opheffen en de andere keer juist kunnen vergroten. De vlakheid van vloer speelt hierin ook een rol

Weitere Informationen

Der Move 2 ist mit bremsbaren Rollen ausgestattet und wird mit unsichtbaren Magneten für eine einfache Konfiguration geliefert

Der Move triangular 1 en Move triangular 2 sind stapelbar. Es ist möglich, diese Tische bis zu sechs zu stapeln

Je nach Konfiguration des Move-Tisches können mehrere Beine an einer Stelle zusammenkommen. Wir können auch nicht garantieren, dass jedes Bein zu 100 Prozent senkrecht steht. Kleine Abweichungen gehören zu jedem handgefertigten Produkt. Aus diesem Grund ist jedes Bein leicht nach innen gedreht. Auch die (Un-)Ebenheit des Bodens kann zur Wahrnehmung von Abweichungen beitragen

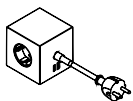
6 **Cable management**

CM16
 Avolt Square 1
 7,6 x 7,6 x 7,6 cm

product

1 **Move**2a **Standard**Move triangular 1

version	dimensions	oak		walnut		Fenix® HPL		transport information		
		veneer	duramas	veneer	duramas	Fenix® HPL, oak legs	Fenix® HPL, walnut legs	colli	m3	kg
Move triangular 1	147x128x75cm	€ 2366	€ 2687	€ 2874	€ 3866	€ 3098	€ 3443	3	0.51	40

Move triangular 2

version	dimensions	oak		walnut		Fenix® HPL		transport information		
		veneer	duramas	veneer	duramas	Fenix® HPL, oak legs	Fenix® HPL, walnut legs	colli	m3	kg
Move triangular 2	147x128x75cm	€ 2475	€ 2844	€ 2977	€ 4072	€ 3298	€ 3649	3	0.51	40

Move triangular high 1

version	dimensions	oak		walnut		Fenix® HPL		transport information		
		veneer	duramas	veneer	duramas	Fenix® HPL, oak legs	Fenix® HPL, walnut legs	colli	m3	kg
Move triangular high 1	147x128x105cm	€ 3159	€ 3516	€ 3751	€ 4780	€ 3981	€ 4447	3	0.51	45

Move triangular high 2

version	dimensions	oak		walnut		Fenix® HPL		transport information		
		veneer	duramas	veneer	duramas	Fenix® HPL, oak legs	Fenix® HPL, walnut legs	colli	m3	kg
Move triangular high 2	147x128x105cm	€ 3358	€ 3661	€ 3957	€ 4992	€ 4187	€ 4659	3	0.51	45

product

1 Move

3 Materials

-

4 Finishes

For an overview of all current Arco colors, please refer to this price list page 5 ff or visit our website www.arco.nl.

5 Additional information

-

6 Cable management

CM16
€ 67

Ordering support

type
 maat
 materiaal blad
 kleur blad
 materiaal poten
 kleur poten
 afwerking tafel
 kleur voetensteun

example

Move triangular high 1
 128x147x105cm
 eiken fineer
 1100 - natural
 eiken massief
 1100 - natural
 N-lak
 5100 - RAL 9010 white

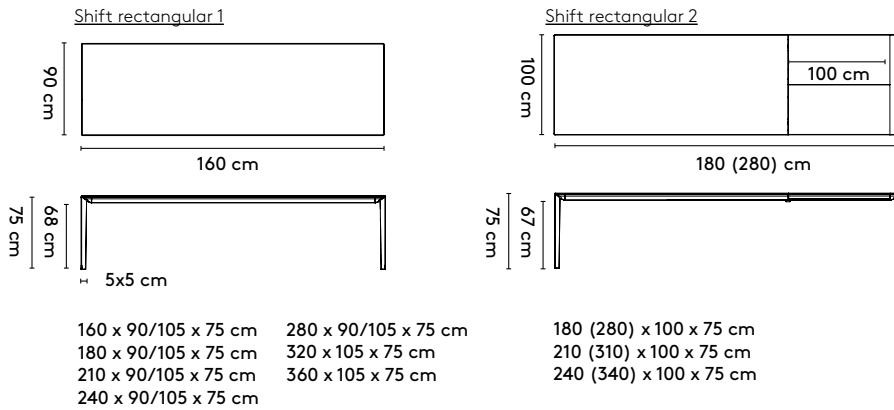
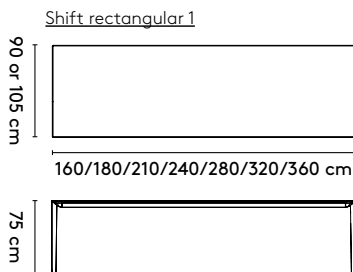
1 **Shift****Jorre
van Ast****2019**2a **Standard**2b **Tailoring**3 **Materials**

Top: oak or walnut (duramas), oak smoked (duramas)
Extension leaf: oak or walnut (duramas), oak smoked (duramas)
Base: epoxy fine texture on aluminum

Materialen

Blad: eiken of noten (duramas), gerookt eiken (duramas)
 Uitschuifblad: eiken of noten (duramas), gerookt eiken (duramas)
 Onderstel: epoxy fine texture op aluminium

Materialien

Platte: Eiche oder Nussbaum (Duramas), Eiche geräuchert (Duramas)
 Einlegeplatte: Eiche oder Nussbaum (Duramas), Eiche geräuchert (Duramas)
 Untergestell: Epoxy fine texture auf Aluminium

4 **Finishes**

All Arco colors and finishes for the mentioned materials

Afwerkingen

Alle Arco kleuren en (lak)afwerkingen voor de genoemde materialen

Ausführungen

Alle Arco Farben und Ausführungen für die genannten Materialien

5 **Additional information**

-

Aanvullende informatie

-

Weitere Informationen

-

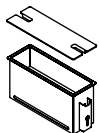
6 **Cable management**

CM06/CM07
epoxy
30/50 cm



CM15
EVOLine® One spot
Ø 5,9 cm



CM08/CM09
cable-net
small/large



CM12
cable sock
large



CM13
zipper sock
short

product

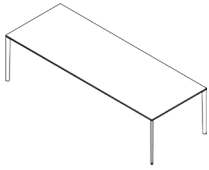
1 **Shift**2a **Standard**Shift Rectangular 1

version	dimensions	oak		smoked oak		walnut	transport information		
		duramas	brushed duramas	duramas	brushed duramas	duramas	colli	m3	kg
Shift Rectangular 1	160x90x75cm	€ 3866	€ 4254	€ 4096	€ 4508	€ 4356	4	0.73	51
Shift Rectangular 1	160x105x75cm	€ 4254	€ 4671	€ 4502	€ 4961	€ 4798	4	0.85	54
Shift Rectangular 1	180x90x75cm	€ 4048	€ 4453	€ 4296	€ 4713	€ 4544	4	0.77	54
Shift Rectangular 1	180x105x75cm	€ 4453	€ 4895	€ 4719	€ 5185	€ 5004	4	0.89	58
Shift Rectangular 1	210x90x75cm	€ 4296	€ 4713	€ 4544	€ 5004	€ 4883	4	0.83	60
Shift Rectangular 1	210x105x75cm	€ 4719	€ 5185	€ 5004	€ 5506	€ 5373	4	0.97	64
Shift Rectangular 1	240x90x75cm	€ 4580	€ 5022	€ 4859	€ 5349	€ 5191	4	0.87	65
Shift Rectangular 1	240x105x75cm	€ 4859	€ 5349	€ 5149	€ 5657	€ 5566	4	1.03	70
Shift Rectangular 1	280x90x75cm	€ 4859	€ 5349	€ 5149	€ 5657	€ 5566	4	0.95	72
Shift Rectangular 1	280x105x75cm	€ 5228	€ 5754	€ 5579	€ 6129	€ 6008	4	1.13	78
Shift Rectangular 1	320x105x75cm	€ 5579	€ 6129	€ 5905	€ 6492	€ 6456	4	1.21	85
Shift Rectangular 1	360x105x75cm	€ 6008	€ 6607	€ 6377	€ 7012	€ 6910	4	1.29	93

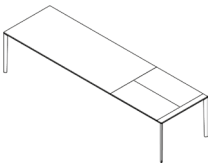
Shift Rectangular 2

version	dimensions	oak		smoked oak		walnut	transport information		
		duramas	brushed duramas	duramas	brushed duramas	duramas	colli	m3	kg
Shift Rectangular 2	180(280)x100x75cm	€ 6147	€ 6770	€ 6662	€ 7182	€ 7212	5	0.86	94
Shift Rectangular 2	210(310)x100x75cm	€ 6770	€ 7448	€ 7152	€ 7872	€ 7896	5	0.92	98
Shift Rectangular 2	240(340)x100x75cm	€ 7139	€ 7865	€ 7581	€ 8343	€ 8271	5	0.98	102

2b **Tailoring**

The widths of the fixed tables are interchangeable for a surcharge of € 275 (gross incl. VAT).
Special lengths aren't possible.

3 **Materials**

-

4 **Finishes**

For an overview of all current Arco colors, please refer to this price list page 5 ff or visit our website www.arco.nl.

5 **Additional information**

-

product

1 **Shift**6 **Cable management**

CM06 € 545	CM07 € 587	CM15 € 152	CM08 € 97	CM09 € 128	CM12 € 79	CM13 € 97
---------------	---------------	---------------	--------------	---------------	--------------	--------------

Ordering support

type
size
material table
color top
finish table
frame
color frame

example

Shift rectangular 2
180(280)x100x75cm
walnut duramas
1000 - pure
oil
epoxy fine texture
5301 - RAL 9005 black

1 **Slim**

**Bertjan
Pot**

2005 - 2024

2a **Standard**

Slim square

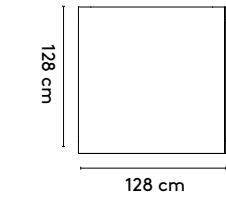

128 x 128 x 75 cm

Slim rectangular

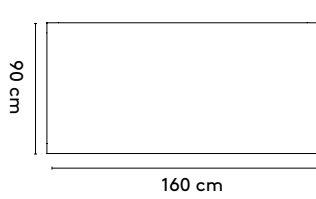

70 x 90 x 75 cm 210 x 90 x 75 cm
140 x 70 x 75 cm 240 x 90 x 75 cm
160 x 90 x 75 cm 280 x 90 x 75 cm
190 x 90 x 75 cm

Slim flex

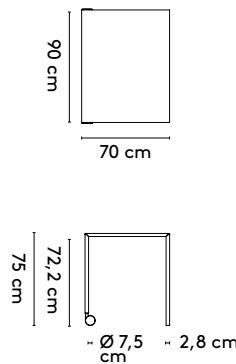

70 x 90 x 75 cm

Slim bench

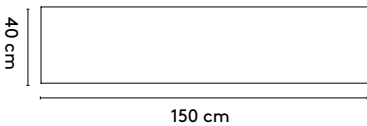

150 x 40 x 45
170 x 40 x 45
200 x 40 x 45

Slim bench cushion

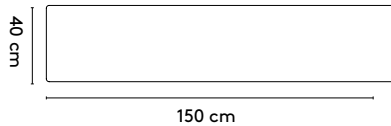

150 x 40
170 x 40
200 x 40



2b **Tailoring**

Slim square

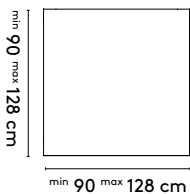

Slim rectangular



* From length 270cm always on request

Slim bench

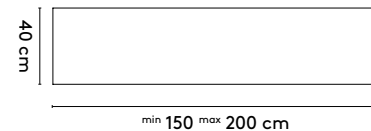

3 **Materials**

Top: oak or walnut (veneer, duramas), oak smoked (duramas), color lacquer on ash (veneer), Fenix® HPL, linoleum (Forbo Furniture coll.)
Legs: oak or walnut (veneer), oak smoked (veneer), color lacquer on ash (veneer)

Materialen

Blad: eiken of noten (fineer, duramas), eiken gerookt (duramas), kleurlak op essen (fineer), Fenix® HPL, linoleum (Forbo Furniture coll.)
Onderstel: eiken of noten (fineer), eiken gerookt (fineer), kleurlak op essen (fineer)

Materialien

Platte: Eiche oder Nussbaum (Furnier, Duramas), Eiche geräuchert (Duramas), Farblack auf Esche (Furnier), Fenix® HPL, linoleum (Forbo Furniture coll.)
Füsse: Eiche oder Nussbaum (Furnier), Eiche geräuchert (Furnier), Farblack auf Esche (Furnier)

4 **Finishes**

All Arco colors and finishes for the mentioned materials

Afwerkingen

Alle Arco kleuren en (lak)afwerkingen voor de genoemde materialen

Ausführungen

Alle Arco Farben und Ausführungen für die genannten Materialien

1 **Slim**

5 Additional information	Aanvullende informatie	Weitere Informationen
<p>The wood grain of the Slim Flex is perpendicular to the wood grain of the Slim table</p> <p>Tolerance in deflection of the leg is +/- 5 mm Tolerance in the total height of the Slim Flex is +/- 2-6 mm (6 mm Linoleum/Fenix) The height of the Slim table varies depending on the chosen material</p>	<p>De fineerrichting van de Slim Flex staat haaks op de fineer richting van de Slim tafel</p> <p>Tolerantie in het wijken van de poot is +/- 5 mm Tolerantie in de totale hoogte van de Slim Flex is +/- 2-6 mm (6 mm Linoleum/Fenix) De hoogte van de Slim tafel varieert afhankelijk van het gekozen materiaal</p>	<p>Die Holzmaserung der Slim Flex ist senkrecht zur Holzmaserung vom Sim Tisch</p> <p>Die Toleranz der Beinauslenkung beträgt +/- 5 mm Die Toleranz in der Gesamthöhe des Slim Flex beträgt +/- 2-6 mm (6 mm Linoleum/Fenix) Die Höhe des Slim-Tisches variiert je nach gewähltem Material</p>

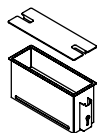
6 **Cable management**

CM06/CM07
epoxy
30/50 cm



CM15
EVOLINE® One spot
Ø 5,9 cm

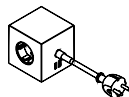

CM16
Avolt Square 1
7,6 x 7,6 x 7,6 cm



CM08/CM09
cable-net
small/large



CM10
cable sock
small



CM13
zipper sock
short

product

1 Slim

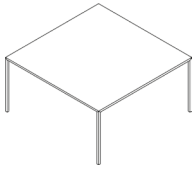
2a **Standard**

Slim square

version	dimensions	oak			smoked oak		walnut		transport information		
		veneer	duramas	brushed duramas	duramas	brushed duramas	veneer	duramas	colli	m3	kg
Slim square	128x128x75cm	€ 4127	€ 4574	€ 5022	€ 5246	€ 5772	€ 4750	€ 5324	3	0.10	36

version	dimensions	laquer	Fenix® HPL			linoleum			transport information		
		color lacquer on ash	Fenix® HPL, oak legs	Fenix® HPL, walnut legs	Fenix® HPL, color lacquer legs	linoleum, oak legs	linoleum, walnut legs	linoleum, color lacquer legs	colli	m3	kg
Slim square	128x128x75cm	€ 4828	€ 4913	€ 5470	€ 5470	€ 4514	€ 5197	€ 5197	3	0.10	36

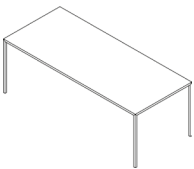

Slim rectangular

version	dimensions	oak			smoked oak		walnut		transport information		
		veneer	duramas	brushed duramas	duramas	brushed duramas	veneer	duramas	colli	m3	kg
Slim rectangular	70x90x75cm	€ 1906	€ 2057	€ 2178	€ 2239	€ 2299	€ 2118	€ 2360	3	0.09	21
Slim rectangular	70x120x75cm	€ 2239	€ 2257	€ 2354	€ 2681	€ 2777	€ 2239	€ 2790	3	0.11	24
Slim rectangular	140x70x75cm	€ 3225	€ 3503	€ 3836	€ 3879	€ 4284	€ 3582	€ 3969	3	0.06	27
Slim rectangular	140x120x75cm	€ 3709	€ 4133	€ 4538	€ 4732	€ 5197	€ 4290	€ 4544	3	0.10	37
Slim rectangular	160x90x75cm	€ 3612	€ 4000	€ 4393	€ 4586	€ 5040	€ 4157	€ 4411	3	0.10	33
Slim rectangular	160x120x75cm	€ 3939	€ 4356	€ 4792	€ 4992	€ 5500	€ 4526	€ 4804	3	0.12	40
Slim rectangular	190x90x75cm	€ 3709	€ 4133	€ 4538	€ 4732	€ 5197	€ 4290	€ 4544	3	0.10	37
Slim rectangular	190x120x75cm	€ 4042	€ 4502	€ 4955	€ 5155	€ 5669	€ 4671	€ 4961	3	0.14	46
Slim rectangular	210x90x75cm	€ 3951	€ 4375	€ 4822	€ 5016	€ 5524	€ 4550	€ 4834	3	0.12	40
Slim rectangular	210x120x75cm	€ 4344	€ 4816	€ 5306	€ 5518	€ 6081	€ 5010	€ 5318	3	0.16	49
Slim rectangular	240x90x75cm	€ 4254	€ 4671	€ 5137	€ 5210	€ 5736	€ 4907	€ 5161	3	0.14	44
Slim rectangular	240x120x75cm	€ 4671	€ 5143	€ 5651	€ 5736	€ 6305	€ 5397	€ 5675	3	0.18	54
Slim rectangular	280x90x75cm	€ 4514	€ 5004	€ 5506	€ 5736	€ 6311	€ 5203	€ 5506	3	0.16	49
Slim rectangular	280x120x75cm	€ 4968	€ 5506	€ 6063	€ 6305	€ 6946	€ 5730	€ 6063	3	0.20	61

product

1 Slim

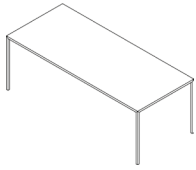
2a **Standard**

Slim rectangular

version	dimensions	laquer	Fenix® HPL			linoleum			transport information		
		color lacquer on ash	Fenix® HPL, oak legs	Fenix® HPL, walnut legs	Fenix® HPL, color lacquer legs	linoleum, oak legs	linoleum, walnut legs	linoleum, color lacquer legs	colli	m3	kg
Slim rectangular	70x90x75cm	€ 1894	€ 2469	€ 2578	€ 2372	€ 2027	€ 2142	€ 1997	3	0.09	21
Slim rectangular	70x120x75cm	€ 2082	€ 2481	€ 2584	€ 2366	€ 2457	€ 2560	€ 2342	3	0.11	24
Slim rectangular	140x70x75cm	€ 3764	€ 3836	€ 4447	€ 4296	€ 3600	€ 4084	€ 4084	3	0.06	27
Slim rectangular	140x120x75cm	€ 4199	€ 4278	€ 4949	€ 4780	€ 4133	€ 4635	€ 4586	3	0.10	37
Slim rectangular	160x90x75cm	€ 4066	€ 4145	€ 4780	€ 4780	€ 3885	€ 4429	€ 4387	3	0.10	33
Slim rectangular	160x120x75cm	€ 4435	€ 4514	€ 5203	€ 5028	€ 4363	€ 4877	€ 4828	3	0.12	40
Slim rectangular	190x90x75cm	€ 4199	€ 4278	€ 4949	€ 4949	€ 4133	€ 4586	€ 4544	3	0.10	37
Slim rectangular	190x120x75cm	€ 4580	€ 4659	€ 5391	€ 5391	€ 4502	€ 5052	€ 5004	3	0.14	46
Slim rectangular	210x90x75cm	€ 4459	€ 4538	€ 5234	€ 5234	€ 4387	€ 4859	€ 4804	3	0.12	40
Slim rectangular	210x120x75cm	€ 4907	€ 4998	€ 5754	€ 5560	€ 4828	€ 5391	€ 5337	3	0.16	49
Slim rectangular	240x90x75cm	€ 4713	€ 4798	€ 5548	€ 5548	€ 4635	€ 5197	€ 5095	3	0.14	44
Slim rectangular	240x120x75cm	€ 5185	€ 5282	€ 6099	€ 5893	€ 5101	€ 5718	€ 5657	3	0.18	54
Slim rectangular	280x90x75cm	€ 5107	€ 5185	€ 5978	€ 5978	€ 5010	€ 5603	€ 5488	3	0.16	49
Slim rectangular	280x120x75cm	€ 5615	€ 5712	€ 6583	€ 6359	€ 5518	€ 6165	€ 6105	3	0.20	61



Slim flex

version	dimensions	oak			smoked oak		walnut		transport information		
		veneer	duramas	brushed duramas	duramas	brushed duramas	veneer	duramas	colli	m3	kg
Slim flex	70x90x75cm	€ 1713	€ 1912	€ 1991	€ 2166	€ 2239	€ 1894	€ 2360	3	0.05	21

version	dimensions	laquer	Fenix® HPL			linoleum			transport information		
		color lacquer on ash	Fenix® HPL, oak legs	Fenix® HPL, walnut legs	Fenix® HPL, color lacquer legs	linoleum, oak legs	linoleum, walnut legs	linoleum, color lacquer legs	colli	m3	kg
Slim flex	70x90x75cm	€ 1973	€ 2269	€ 2336	€ 2148	€ 1840	€ 2094	€ 2094	3	0.05	21

product

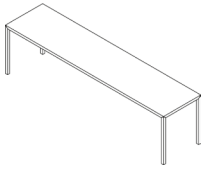
1 **Slim**2a **Standard**Slim bench

version	dimensions	oak			smoked oak		walnut		laquer	transport information		
		veneer	duramas	brushed duramas	duramas	brushed duramas	veneer	duramas	color lacquer on ash	colli	m3	kg
Slim bench	150x40x45cm	€ 1888	€ 2088	€ 2160	€ 2390	€ 2457	€ 2094	€ 2572	€ 2033	3	0.03	22
Slim bench	170x40x45cm	€ 1943	€ 2142	€ 2318	€ 2433	€ 2511	€ 2191	€ 2614	€ 2136	3	0.03	24
Slim bench	200x40x45cm	€ 2021	€ 2215	€ 2475	€ 2505	€ 2741	€ 2336	€ 2693	€ 2281	3	0.04	27

Slim bench cushion

version	dimensions	fabric							transport information		
		fabric group basic	fabric group 1	fabric group 2	fabric group 3	fabric group 4	fabric group 5	COM	colli	m3	kg
Slim bench cushion	≤ 150 cm	€ 733	€ 769	€ 811	€ 847	€ 902	€ 993	€ 733	1	0.02	2
Slim bench cushion	151 to 240 cm	€ 781	€ 817	€ 866	€ 896	€ 950	€ 1041	€ 781	1	0.04	2

2b **Tailoring**

Within the limits indicated on the factsheet: price of the next larger length or width with a surcharge of € 275 (gross incl. VAT). In case of a deviation in both length and width, the next length size is considered first and then the next larger width.

Slim bench cushion

COM: 1,1 meter gross of plain fabric, minimum width 130 cm.

The Slim bench cushion is not available in special width.

3 **Materials**

-

4 **Finishes**

For an overview of all current Arco colors, please refer to this price list page 5 ff or visit our website www.arco.nl.

5 **Additional information**

-

product

1 **Slim**6 **Cable management**

CM06 € 545	CM07 € 587	CM15 € 152	CM16 € 67	CM08 € 97	CM09 € 128	CM10 € 49	CM13 € 97
---------------	---------------	---------------	--------------	--------------	---------------	--------------	--------------

Ordering support

example

type
size
material top
color top
material sides and legs
color sides and legs
finish sides and legs

Slim rectangular
210x90x75cm
Fenix®HPL
7300 - black
oak veneer
1301 - black
P-lacquer

1 **Slim+**

**Bertjan
Pot**

2011 - 2024

2a **Standard**

Slim+ rectangular

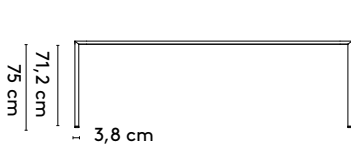
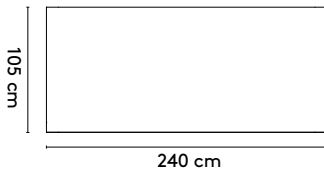

70 x 105/120 x 75 cm 300 x 105/120 x 75 cm
 240 x 105/120 x 75 cm 320 x 105/120 x 75 cm
 280 x 105/120 x 75 cm 360 x 105/120 x 75 cm

Slim+ rectangular high

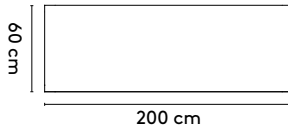

200 x 60/90 x 105 cm
 240 x 60/90 x 105 cm
 280 x 90 x 105 cm

Slim+ flex

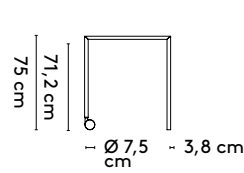
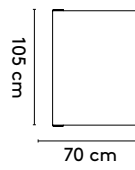

70 x 105 x 75 cm

Slim+ round

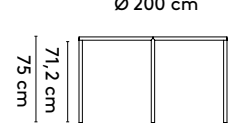
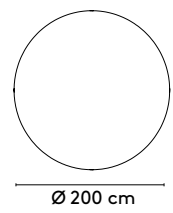

Ø 160 x 75 cm (3 legs)
 Ø 200 x 75 cm (4 legs)

Slim+ connected

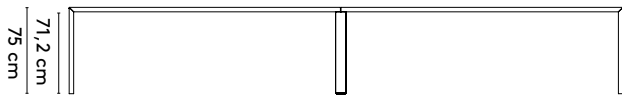
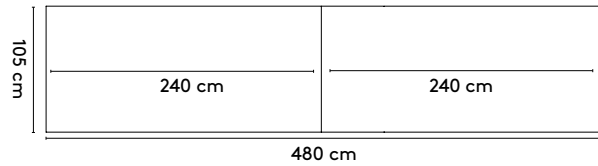

480 x 105/120 x 75 cm 640 x 105/120 x 75 cm
 560 x 105/120 x 75 cm 720 x 105/120 x 75 cm

Slim+ bench

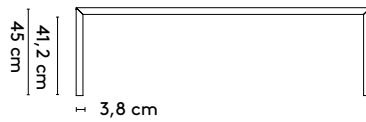
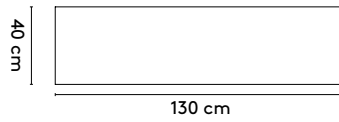

130 x 40 x 45
 150 x 40 x 45
 200 x 40 x 45
 240 x 40 x 45

Slim+ bench cushion

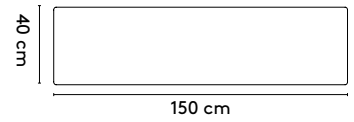

130 x 40
 150 x 40
 200 x 40
 240 x 40

2b **Tailoring**

Slim+ rectangular

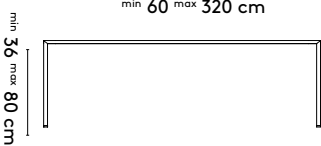
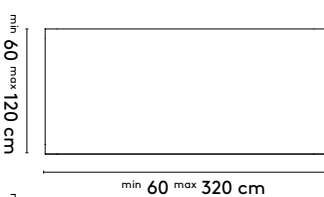

a Slim+ rectangular table top with a length longer than 320 cm only has a maximum width of 105 cm

Slim+ rectangular high

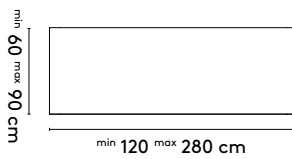

Slim+ round

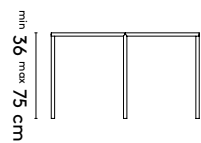
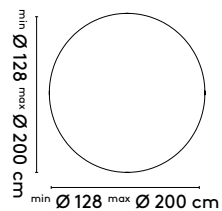

Ø 128-160 cm (3/4 legs)
 Ø 161-200 cm (4 legs)

Slim+ connected

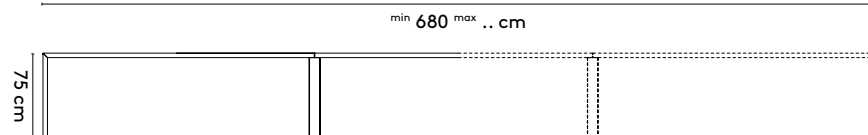
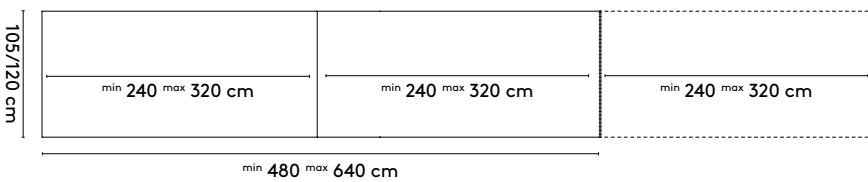

Slim+ bench

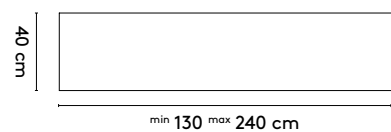

1 **Slim+**

<p>3 <u>Materials</u></p> <p>Top: oak or walnut (veneer, duramas), oak smoked (duramas), color lacquer on ash (veneer), Fenix® HPL, linoleum (Forbo Furniture coll.)</p> <p>Legs: oak or walnut (veneer), oak smoked (veneer), color lacquer on ash (veneer)</p>	<p><u>Materialen</u></p> <p>Blad: eiken of noten (fineer, duramas), gerookt eiken (duramas), kleurlak op essen (fineer), Fenix® HPL, linoleum (Forbo Furniture coll.)</p> <p>Onderstel: eiken of noten (fineer), gerookt eiken (fineer), kleurlak op essen (fineer)</p>	<p><u>Materialien</u></p> <p>Platte: Eiche oder Nussbaum (Furnier, Duramas), Eiche geräuchert (Duramas), Farblack auf Esche (Furnier), Fenix® HPL, linoleum (Forbo Furniture coll.)</p> <p>Füsse: Eiche oder Nussbaum (Furnier), Eiche geräuchert (Furnier), Farblack auf Esche (Furnier)</p>
<p>4 <u>Finishes</u></p> <p>All Arco colors and finishes for the mentioned materials</p>	<p><u>Afwerkingen</u></p> <p>Alle Arco kleuren en (lak)afwerkingen voor de genoemde materialen</p>	<p><u>Ausführungen</u></p> <p>Alle Arco Farben und Ausführungen für die genannten Materialien</p>
<p>5 <u>Additional information</u></p> <p>The wood grain of the Slim+ Flex is perpendicular to the wood grain of the Slim+ table</p> <p>Tolerance in deflection of the leg is +/- 5 mm. Tolerance in the total height of the Slim+ Flex is +/- 2-6 mm (6 mm Linoleum/Fenix)</p> <p>The height of the Slim+ table varies depending on the chosen material</p> <p>Cable management is not possible for the Slim+ Round up to Ø160 cm</p>	<p><u>Aanvullende informatie</u></p> <p>De fineerrichting van de Slim+ Flex staat haaks op de fineer richting van de Slim+ tafel</p> <p>Tolerantie in het wijken van de poot is +/- 5 mm. Tolerantie in de totale hoogte van de Slim+ Flex is +/- 2-6 mm (6 mm Linoleum/Fenix)</p> <p>De hoogte van de Slim+ tafel varieert afhankelijk van het gekozen materiaal</p> <p>Cable management is niet mogelijk bij de Slim+ Round t/m Ø160 cm</p>	<p><u>Weitere Informationen</u></p> <p>Die Holzmaserung der Slim+ Flex ist senkrecht zur Holzmaserung vom Slim+ Tisch</p> <p>Die Toleranz der Beinauslenkung beträgt +/- 5 mm. Die Toleranz in der Gesamthöhe des Slim+ Flex beträgt +/- 2-6 mm (6 mm Linoleum/Fenix)</p> <p>Die Höhe des Slim+ Tisches variiert je nach gewähltem Material</p> <p>Kabelmanagement ist bei Slim+ Round bis Ø160 cm nicht möglich</p>

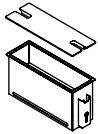
6 Cable management

CM06/CM07
epoxy
30/50 cm



CM15
EVoline® One spot
Ø 5,9 cm

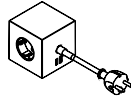

CM16
Avolt Square 1
7,6 x 7,6 x 7,6 cm



CM08/CM09
cable-net
small/large



CM10
cable sock
small



CM13/CM14
zipper sock
short/long

product

1 Slim+

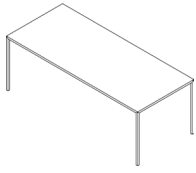
2a Standard

Slim+ rectangular

version	dimensions	oak			smoked oak		walnut		transport information		
		veneer	duramas	brushed duramas	duramas	brushed duramas	veneer	duramas	colli	m3	kg
Slim+ rectangular	70x105x75cm	€ 2100	€ 2299	€ 2390	€ 2475	€ 2572	€ 2142	€ 2681	3	0.10	42
Slim+ rectangular	70x120x75cm	€ 2070	€ 2414	€ 2511	€ 2717	€ 2826	€ 2275	€ 2856	3	0.13	38
Slim+ rectangular	240x105x75cm	€ 4925	€ 5452	€ 6002	€ 6050	€ 6662	€ 5669	€ 6643	3	0.34	88
Slim+ rectangular	240x120x75cm	€ 5312	€ 5694	€ 6262	€ 6534	€ 7194	€ 5917	€ 7170	3	0.37	70
Slim+ rectangular	280x105x75cm	€ 5258	€ 5845	€ 6426	€ 6698	€ 7369	€ 6081	€ 7115	3	0.37	99
Slim+ rectangular	280x120x75cm	€ 5681	€ 6099	€ 6704	€ 6988	€ 7684	€ 6347	€ 7678	3	0.43	78
Slim+ rectangular	320x105x75cm	€ 5948	€ 6595	€ 7242	€ 7333	€ 8077	€ 6631	€ 8017	3	0.43	110
Slim+ rectangular	320x120x75cm	€ 6208	€ 6879	€ 7563	€ 7920	€ 8725	€ 7158	€ 8664	3	0.49	86
Slim+ rectangular	360x105x75cm	€ 6776	€ 7273	€ 7986	€ 8374	€ 9209	€ 7569	€ 9166	3	0.49	121

version	dimensions	laquer	Fenix® HPL			linoleum			transport information		
		color lacquer on ash	Fenix® HPL, oak legs	Fenix® HPL, walnut legs	Fenix® HPL, color lacquer legs	linoleum, oak legs	linoleum, walnut legs	linoleum, color lacquer legs	colli	m3	kg
Slim+ rectangular	70x105x75cm	€ 2221	€ 2669	€ 2669	€ 2523	€ 2197	€ 2493	€ 2493	3	0.10	42
Slim+ rectangular	70x120x75cm	€ 2396	€ 2632	€ 2796	€ 2796	€ 2608	€ 2699	€ 2699	3	0.13	38
Slim+ rectangular	240x105x75cm	€ 5560	€ 5657	€ 6534	€ 6311	€ 5300	€ 5996	€ 5996	3	0.34	88
Slim+ rectangular	240x120x75cm	€ 6008	€ 6105	€ 6813	€ 6813	€ 5724	€ 6474	€ 6474	3	0.37	70
Slim+ rectangular	280x105x75cm	€ 5960	€ 6063	€ 7158	€ 6916	€ 5681	€ 6571	€ 6571	3	0.37	99
Slim+ rectangular	280x120x75cm	€ 6438	€ 6547	€ 7472	€ 7472	€ 6135	€ 7097	€ 7097	3	0.43	78
Slim+ rectangular	320x105x75cm	€ 6728							3	0.43	110
Slim+ rectangular	320x120x75cm	€ 7273							3	0.49	86
Slim+ rectangular	360x105x75cm	€ 7829							3	0.49	121



Slim+ round

version	dimensions	oak		smoked oak	walnut		laquer	transport information		
		veneer	duramas	duramas	veneer	duramas	color lacquer on ash	colli	m3	kg
Slim+ round	160x75cm	€ 5222	€ 5760	€ 6432	€ 6057	€ 6474	€ 5802	3	0.34	174
Slim+ round	200x75cm	€ 6686	€ 7236	€ 8041	€ 7430	€ 8023	€ 7351	3	0.49	189

product

1 Slim+

2a Standard

Slim+ flex

version	dimensions	oak			smoked oak		walnut		transport information		
		veneer	duramas	brushed duramas	duramas	brushed duramas	veneer	duramas	colli	m3	kg
Slim+ flex	70x105x75cm	€ 1949	€ 2142	€ 2354	€ 2330	€ 2590	€ 2185	€ 2535	3	0.06	37

version	dimensions	laquer	Fenix® HPL			linoleum			transport information		
		color lacquer on ash	Fenix® HPL, oak legs	Fenix® HPL, walnut legs	Fenix® HPL, color lacquer legs	linoleum, oak legs	linoleum, walnut legs	linoleum, color lacquer legs	colli	m3	kg
Slim+ flex	70x105x75cm	€ 2306	€ 2505	€ 2662	€ 2662	€ 2088	€ 2572	€ 2572	3	0.06	37

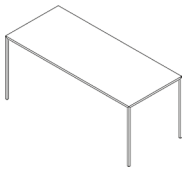

Slim+ rectangular high

version	dimensions	oak			smoked oak		walnut		transport information		
		veneer	duramas	brushed duramas	duramas	brushed duramas	veneer	duramas	colli	m3	kg
Slim+ rectangular high	200x60x105cm	€ 3866	€ 4290	€ 4707	€ 4780	€ 5246	€ 4223	€ 5228	3	0.16	53
Slim+ rectangular high	200x90x105cm	€ 4108	€ 4550	€ 5016	€ 5234	€ 5772	€ 4508	€ 5748	3	0.25	68
Slim+ rectangular high	240x60x105cm	€ 4114	€ 4550	€ 5016	€ 5070	€ 5585	€ 4496	€ 5554	3	0.19	59
Slim+ rectangular high	240x90x105cm	€ 4381	€ 4865	€ 5349	€ 5609	€ 6165	€ 4822	€ 6141	3	0.28	77
Slim+ rectangular high	280x90x105cm	€ 4659	€ 5173	€ 5687	€ 5954	€ 6547	€ 5119	€ 6510	3	0.34	86

version	dimensions	laquer	Fenix® HPL			linoleum			transport information		
		color lacquer on ash	Fenix® HPL, oak legs	Fenix® HPL, walnut legs	Fenix® HPL, color lacquer legs	linoleum, oak legs	linoleum, walnut legs	linoleum, color lacquer legs	colli	m3	kg
Slim+ rectangular high	200x60x105cm	€ 4375	€ 4453	€ 4901	€ 4901	€ 4175	€ 4550	€ 4502	3	0.16	53
Slim+ rectangular high	200x90x105cm	€ 4647	€ 4732	€ 5210	€ 5210	€ 4574	€ 4883	€ 4780	3	0.25	68
Slim+ rectangular high	240x60x105cm	€ 4647	€ 4611	€ 5076	€ 5076	€ 4453	€ 4762	€ 4659	3	0.19	59
Slim+ rectangular high	240x90x105cm	€ 4961	€ 5040	€ 5754	€ 5754	€ 4871	€ 5337	€ 5282	3	0.28	77
Slim+ rectangular high	280x90x105cm	€ 5264	€ 5355	€ 6026	€ 6026	€ 5173	€ 5645	€ 5591	3	0.34	86

product

1 Slim+

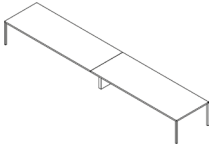
2a StandardSlim+ connected

version	dimensions	oak			smoked oak		walnut		laquer	Fenix® HPL			transport information		
		veneer	duramas	brushed duramas	duramas	brushed duramas	veneer	duramas	color lacquer on ash	Fenix® HPL, oak legs	Fenix® HPL, walnut legs	Fenix® HPL, color lacquer legs	colli	m3	kg
Slim+ connected	480x105x75cm	€ 11804	€ 13099	€ 14412	€ 15059	€ 16553	€ 13625	€ 16511	€ 13807	€ 13571	€ 15682	€ 15682	4	0.80	150
Slim+ connected	480x120x75cm	€ 13177					€ 14212		€ 13317	€ 14817	€ 15761	€ 15761	4	0.80	170
Slim+ connected	560x105x75cm	€ 12639	€ 14018	€ 15416	€ 16118	€ 17733	€ 14587	€ 17666	€ 14781	€ 14533	€ 17182	€ 17182	4	1.20	210
Slim+ connected	560x120x75cm	€ 13849					€ 14962		€ 14018	€ 15422	€ 16420	€ 16420	4	1.20	230
Slim+ connected	640x105x75cm	€ 14254	€ 15821	€ 17400	€ 18193	€ 20008	€ 16463	€ 19929	€ 16698				4	1.60	270
Slim+ connected	640x120x75cm	€ 15210					€ 16456		€ 18253				4	1.60	290
Slim+ connected	720x105x75cm	€ 16263	€ 18054	€ 19863	€ 20764	€ 22839	€ 18780	€ 22748	€ 19439				4	2.00	340
Slim+ connected	720x120x75cm	€ 20552					€ 24424		€ 23015				4	1.60	290

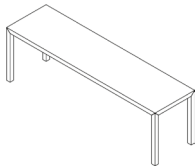
Slim+ bench

version	dimensions	oak			smoked oak		walnut		laquer	transport information		
		veneer	duramas	brushed duramas	duramas	brushed duramas	veneer	duramas	color lacquer on ash	colli	m3	kg
Slim+ bench	130x40x45cm	€ 2027	€ 2191	€ 2408	€ 2463	€ 2699	€ 2281	€ 2360	€ 2227	3	0.05	37
Slim+ bench	150x40x45cm	€ 2106	€ 2281	€ 2511	€ 2535	€ 2802	€ 2372	€ 2457	€ 2318	3	0.05	34
Slim+ bench	200x40x45cm	€ 2263	€ 2463	€ 2699	€ 2735	€ 3013	€ 2560	€ 2638	€ 2499	3	0.06	40
Slim+ bench	240x40x45cm	€ 2372	€ 2572	€ 2838	€ 2868	€ 3165	€ 2681	€ 2759	€ 2620	3	0.06	44

Slim+ bench cushion

version	dimensions	fabric							transport information		
		fabric group basic	fabric group 1	fabric group 2	fabric group 3	fabric group 4	fabric group 5	COM	colli	m3	kg
Slim+ bench cushion	≤ 150 cm	€ 733	€ 769	€ 811	€ 847	€ 902	€ 993	€ 733	1	0.02	2
Slim+ bench cushion	151 to 240 cm	€ 781	€ 817	€ 866	€ 896	€ 950	€ 1041	€ 781	1	0.04	2

product

1 **Slim+**2b **Tailoring**

Within the limits indicated on the factsheet: price of the next larger length or width with a surcharge of € 275 (gross incl. VAT). In case of a deviation in both length and width, the next length size is considered first and then the next larger width.

Slim+ bench cushion

COM: 1,1 meter gross of plain fabric, minimum width 130 cm.

The Slim+ bench cushion is not available in special width.

3 **Materials**

-

4 **Finishes**

For an overview of all current Arco colors, please refer to this price list page 5 ff or visit our website www.arco.nl.

5 **Additional information**

-

6 **Cable management**

CM06	CM07	CM15	CM16	CM08	CM09	CM10	CM13	CM14
€ 545	€ 587	€ 152	€ 67	€ 97	€ 128	€ 49	€ 97	€ 128

Ordering support

example

type	Slim+ rectangular
size	280x105x75cm
material top	Fenix® HPL
color top	7300 - black
material sides and legs	oak veneer
color sides and legs	1301 - black
finish sides and legs	P-lacquer

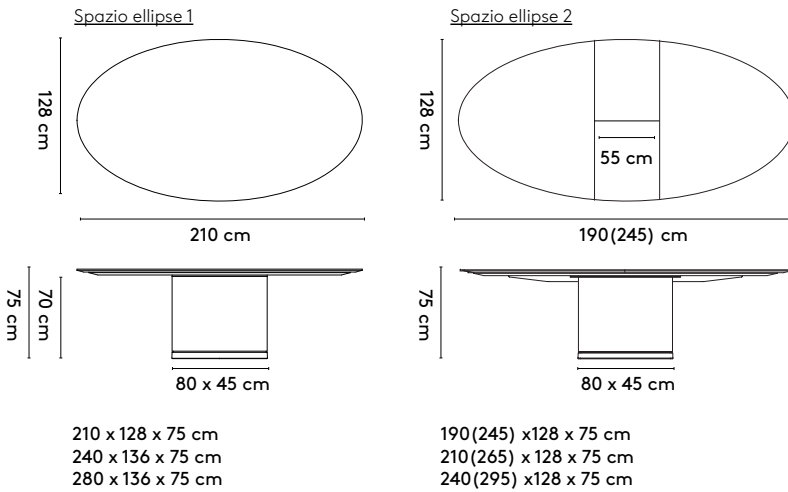
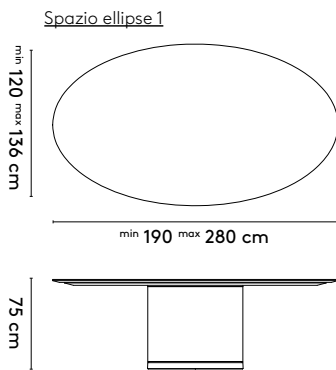
1 **Spazio****Willem
van Ast****2007**2a **Standard**2b **Tailoring**3 **Materials**

Top: oak (veneer, duramas), oak or walnut (solid), oak smoked (solid)
Extension leaf: oak (veneer, duramas)
Column: oak or walnut (veneer), color lacquer on mdf
Base: color lacquer on concrete

Materialen

Blad: eiken (fineer, duramas), eiken of noten (massief), gerookt eiken (massief)
 Uitschuifblad: eiken (fineer, duramas)
 Kolom: eiken of noten (fineer), kleurlak op mdf
 Voet: kleurlak op beton

Materialien

Platte: Eiche (Furnier, Duramas), Eiche oder Nussbaum (Massiv), Eiche geräuchert (Massiv)
 Einlegeplatte: Eiche (Furnier, Duramas)
 Säule: Eiche oder Nussbaum (Furnier), Farblack auf mdf
 Füß: Farblack auf Beton

4 **Finishes**

All Arco colors and finishes for the mentioned materials

Afwerkingen

Alle Arco kleuren en (lak)afwerkingen voor de genoemde materialen

Ausführungen

Alle Arco Farben und Ausführungen für die genannten Materialien

5 **Additional information**

-

Aanvullende informatie

-

Weitere Informationen

-

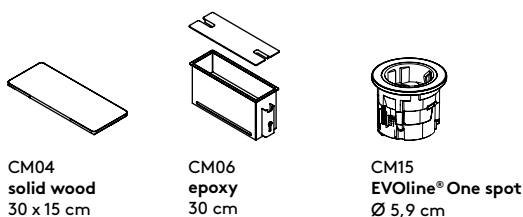
6 **Cable management**

product

1 Spazio

2a Standard

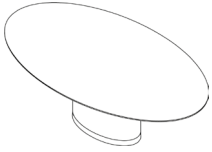

Spazio ellipse 1

version	dimensions	oak			smoked oak		walnut	transport information		
		veneer	solid	brushed solid	solid	brushed solid	solid	colli	m3	kg
Spazio ellipse 1	210x128x75cm	€ 4756	€ 6123	€ 6601	€ 6583	€ 7236	€ 7303	3	1.09	125
Spazio ellipse 1	240x136x75cm	€ 5167	€ 6758		€ 7357		€ 8180	3	1.17	140
Spazio ellipse 1	280x136x75cm	€ 5494	€ 7381		€ 8101		€ 8997	3	1.27	154

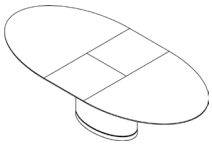

Spazio ellipse 2

version	dimensions	oak		transport information		
		veneer	duramas	colli	m3	kg
Spazio ellipse 2	190(245)x128x75cm	€ 6728	€ 7199	4	1.05	133
Spazio ellipse 2	210(265)x128x75cm	€ 6813	€ 7290	4	1.09	139
Spazio ellipse 2	240(295)x128x75cm	€ 7018	€ 7510	4	1.15	148

2b Tailoring

Possible for solid tables.

Within the limits indicated on the factsheet: price of the next larger length or width with a surcharge of € 275 (gross incl. VAT). In case of a deviation in both length and width, the next length size is considered first and then the next larger width.

3 Materials

-

4 Finishes

For an overview of all current Arco colors, please refer to this price list page 5 ff or visit our website www.arco.nl.

5 Additional information

-

product

1 **Spazio**6 **Cable management**

CM04	CM06	CM15
€ 708	€ 545	€ 152

Ordering support

type	example
size	Spazio ellipse 2
material top	240 (295)x128x75cm
color top	veneer walnut
finish top	1000 - pure
color extension leaf	N-lacquer
finish extension leaf	1000 - pure
color laquer base plate	N-lacquer
	5802 - astro silver dark

1 **Trestle****Jorre
van Ast**

2017 - 2018

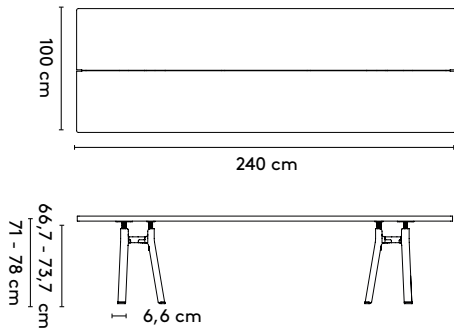
2a **Standard**Trestle rectangular 2

240 x 100/140 x 71-78 cm (between legs: 178/158/138 cm)
 280 x 100/140 x 71-78 cm (between legs: 218/198/178 cm)
 320 x 105/140 x 71-78 cm (between legs: 258/238/218 cm)
 360 x 105/140 x 71-78 cm (between legs: 258 cm)

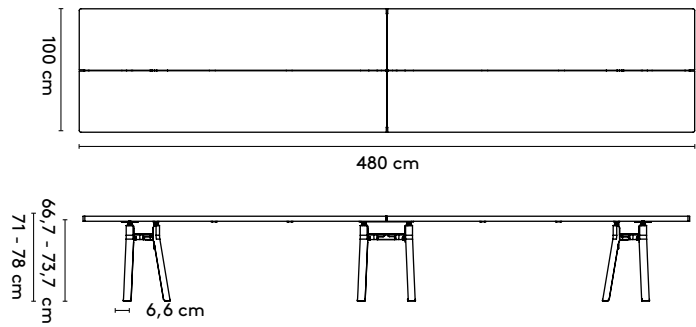
Trestle rectangular 2 connected

480 x 100/140 x 71-78 cm (between legs: 178/158/138 cm)
 560 x 100/140 x 71-78 cm (between legs: 218/198/178 cm)

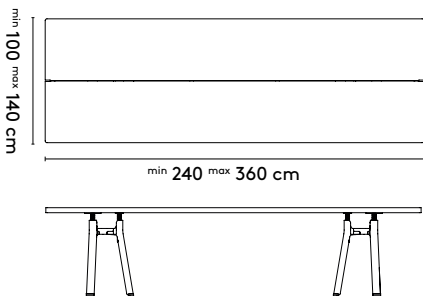
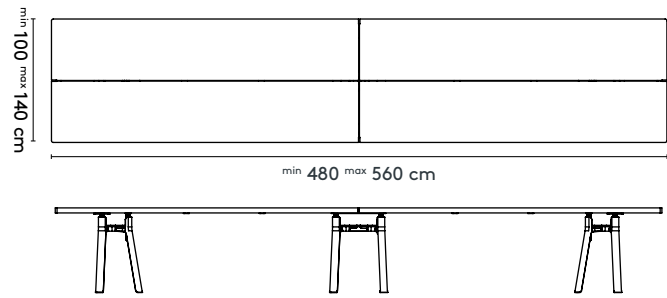
2b **Tailoring**Trestle rectangular 2Trestle rectangular 2 connected3 **Materials**

Top: oak (solid, local wood) or walnut (solid), oak smoked (solid)
Legs: epoxy fine texture on aluminum

Materialen

Blad: eiken (massief, lokaal hout) of noten (massief), eiken gerookt (massief)
Onderstel: epoxy fine texture op aluminium

Materialien

Platte: Eiche (Massiv, lokales Holz) oder Nussbaum (Massiv), Eiche geräuchert (Massiv)
Untergestell: Epoxy fine texture auf Aluminium

4 **Finishes**

All Arco colors and finishes for the mentioned materials

Afwerkingen

Alle Arco kleuren en (lak)afwerkingen voor de genoemde materialen

Ausführungen

Alle Arco Farben und Ausführungen für die genannten Materialien

5 **Additional information**

Legs can be mounted at 30, 40 or 50 cm from the short side of the table.
 Legs can be mounted at 50 cm only for size 360 cm

Aanvullende informatie

Onderstel kan worden gemonteerd op 30, 40, 50 cm van de korte zijde van de tafel
 Onderstel kan bij 360 cm alleen op 50 cm worden gemonteerd

Weitere Informationen

Untergestell kann auf 30, 40 und 50 cm der kurze Seite des Tisches montiert werden
 Untergestell kann bei 360 cm nur auf 50 cm montiert werden

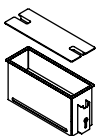
6 **Cable management**

CM06/CM07
epoxy
30/50 cm



CM15
EVOLINE® One spot
Ø 5,9 cm



CM08/CM09
cable-net
small/large



CM11
cable sock
medium



CM13
zipper sock
short

product

1 Trestle

2a Standard

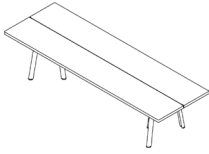

Trestle rectangular 2

version	dimensions	local oak		smoked oak		walnut	transport information		
		solid	brushed solid	solid	brushed solid	solid	colli	m3	kg
Trestle rectangular 2	240x100x71-78cm	€ 5815	€ 6432	€ 6891	€ 7557	€ 9378	5	0.23	117
Trestle rectangular 2	240x140x71-78cm	€ 7158	€ 7914	€ 8470	€ 9293	€ 11538	5	0.32	170
Trestle rectangular 2	280x100x71-78cm	€ 6444	€ 7097	€ 7599	€ 8368	€ 10419	5	0.27	131
Trestle rectangular 2	280x140x71-78cm	€ 7932	€ 8719	€ 9348	€ 10292	€ 12820	5	0.36	189
Trestle rectangular 2	320x105x71-78cm	€ 7230	€ 7666	€ 8531	€ 9348	€ 11780	5	0.32	149
Trestle rectangular 2	320x140x71-78cm	€ 8604	€ 9475	€ 10146	€ 11126	€ 14012	5	0.43	208
Trestle rectangular 2	360x105x71-78cm	€ 7859	€ 8337	€ 9257	€ 10189	€ 12445	5	0.36	164
Trestle rectangular 2	360x140x71-78cm	€ 9354	€ 10298	€ 11018	€ 12119	€ 14805	5	0.47	227



Trestle rectangular 2 connected

version	dimensions	local oak		smoked oak		walnut	transport information		
		solid	brushed solid	solid	brushed solid	solid	colli	m3	kg
Trestle rectangular 2 connected	480x100x71-78cm	€ 10225	€ 11302	€ 13075	€ 14351	€ 17527	7	2.20	250
Trestle rectangular 2 connected	480x140x71-78cm	€ 13710	€ 15216	€ 17697	€ 19488	€ 23934	7	2.05	250
Trestle rectangular 2 connected	560x100x71-78cm	€ 11338	€ 12476	€ 14436	€ 15888	€ 19354	7	2.40	295
Trestle rectangular 2 connected	560x140x71-78cm	€ 15271	€ 16862	€ 19602	€ 21635	€ 26493	7	2.25	295

2b Tailoring

Within the limits indicated on the factsheet: price of the next larger length or width with a surcharge of € 275 (gross incl. VAT).
In case of a deviation in both length and width, the next length size is considered first and then the next larger width.

3 Materials

-

4 Finishes

For an overview of all current Arco colors, please refer to this price list page 5 ff or visit our website www.arco.nl.

5 Additional information

-

product

1 **Trestle**6 **Cable management**

CM06 € 545	CM07 € 587	CM15 € 152	CM08 € 97	CM09 € 128	CM11 € 67	CM13 € 97
---------------	---------------	---------------	--------------	---------------	--------------	--------------

Ordering support

type	example
size	Trestle rectangular 2
material top	320x105x71-78cm
color top	oak solid smoked
finish top	1000 - pure
material legs	oil
color legs	epoxy fine texture
	5301 - RAL 9005 black

Cable Management Overview

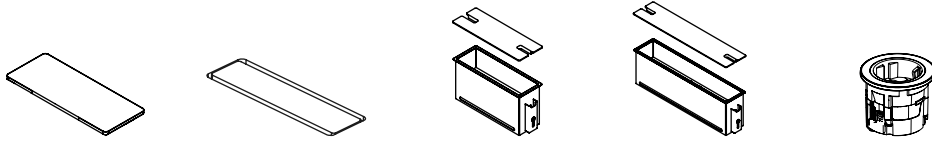

Table	CM04	CM05	CM06	CM07	CM15	Page
Balance						26
Base			X	X	X	30
Cast			X	X	X	34
Dew					X	38
Essential					X	40
Essenza	X		X	X	X	44
Extend						52
Grid	X	X			X	56
HAT					X	64
Joist						66
Kami	X	X	X	X	X	70
Move						78
Shift			X	X	X	82
Slim			X	X	X	86
Slim+			X	X	X	92
Spazio	X		X		X	98
Trestle			X	X	X	102

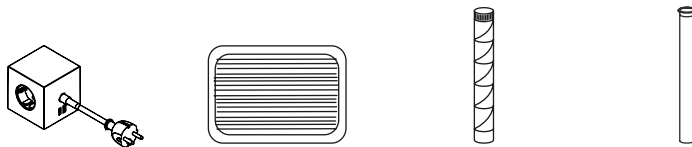

Table	CM16	CM08/09	CM10/11/12	CM13/14	Page
Balance					26
Base		X	CM12	X	30
Cast		X	CM12	X	34
Dew		X			38
Essential		X			40
Essenza		X	CM12	X	44
Extend	X				52
Grid			CM11	X	56
HAT	X				64
Joist					66
Kami		X			70
Move	X				78
Shift		X	CM12	X	82
Slim	X	X	CM10	X	86
Slim+	X	X	CM10	X	92
Spazio					98
Trestle		X	CM11	X	102

1 Cut outs (CM18/19/20)

we can offer (tailored) cut outs for cable management solutions outside Arco's collection

we can only accept an order with cut out if we receive a drawing with the dimensions and desired position along with the order confirmation, we will send our drawing with the dimensions for checking and approval of the cut out

2 Standard

CM18 (for all tables except Slim(+) family)

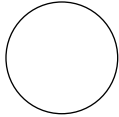

circle



rectangular



square

CM19 (for Slim(+) family)

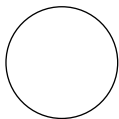

circle

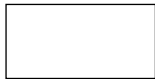

rectangular



square

(max. cut out dimension: 560mmx110mm)

CM20 (for all tables except Slim(+) family)

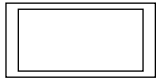

cut out for built-in modules from e.g. Bachmann (possibly also with extra mounting holes)

3 Materials

-

Materialen

-

Materialien

-

4 Finishes

-

Afwerkingen

-

Ausführungen

-

5 Additional information

For non-solid tables, the inner core and unfinished edges will become visible. We recommend taking this into account in the design, for instance by applying an 3mm cover edge.

Splintering as a result of the cut out may not be a reason for rejection of the table.

For CM20, please note:
built-in modules must be installed and connected on site by a qualified electrician

Aanvullende informatie

Bij niet-massieve tafels worden de binnenkern en onafgewerkte randen zichtbaar. Wij raden aan om hier in het ontwerp rekening mee te houden door bijvoorbeeld een kraag van 3 mm aan te brengen. Splinters als gevolg van de uitsnede mogen geen reden zijn voor afkeuring van de tafel.

Voor CM20, let op:
ingebouwde modules moeten ter plaatse worden geïnstalleerd en aangesloten door een gekwalificeerde elektricien

Weitere Informationen

Bei Tischen, die nicht aus Massivholz bestehen, werden der Kern und die unbearbeiteten Kanten sichtbar. Dies sollte beim Entwurf berücksichtigt werden, z. B. durch das Anbringen eines 3 mm breiten Rahmens. Splitter, die beim Ausschchnitt entstehen, sind kein Grund zur Reklamation des Tisches.

Zu beachten bei CM20:
Einbaumodule müssen vor Ort von einer Elektrofachkraft installiert und angeschlossen werden.

product

1 Cut outs (CM18/19/20)

2a Standard

		CM18	transport information		
version	cut out	CM18	colli	m3	kg
CM18	startup costs and first cut out per table	€ 212	0	0.00	0
CM18	each subsequent cut out	€ 91	0	0.00	0

		CM19	transport information		
version	cut out	CM19	colli	m3	kg
CM19	startup costs and first cut out per table	€ 424	0	0.00	0
CM19	each subsequent cut out	€ 182	0	0.00	0

		CM20	transport information		
version	cut out	CM20	colli	m3	kg
CM20	startup costs and first cut out per table	€ 424	0	0.00	0
CM20	each subsequent cut out	€ 91	0	0.00	0

3 Materials

-

4 Finishes

-

5 Additional information

-

Ordering support

type
position(s)
dimensions

example

CM18
indicate on drawing
indicate on drawing

1 CM08/09 CM10/11/12 CM13/14

2 Standard

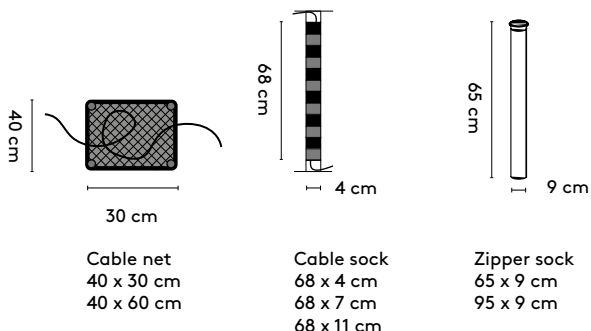

Cable net
40 x 30 cm
40 x 60 cm

Cable sock
68 x 4 cm
68 x 7 cm
68 x 11 cm

Zipper sock
65 x 9 cm
95 x 9 cm

3 Materials

Cable sock
3d knitted fabric (black, green/blue, red/blue)

Cable net
Knitted fabric, synthetic (black)

Zipper sock
3d knitted fabric (black)

Materialen

Cable sock
3d gebreide stof (black, green/blue, red/blue)

Cable net
Gebreide stof, kunststof (black)

Zipper sock
3d gebreide stof (black)

Materialien

Cable sock
3d gestrickter Stoff (black, green/blue, red/blue)

Cable net
Gestrickter Stoff, Kunststoff (black)

Zipper sock
3d gestrickter Stoff (black)

4 Finishes

-

Afwerkingen

-

Ausführungen

-

5 Additional information

-

Aanvullende informatie

-

Weitere Informationen

-

product

1 CM08/09 CM10/11/12 CM13/14

2a Standard

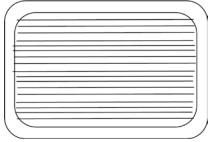

CM08

version	dimensions	fabric	transport information		
		fabric	colli	m3	kg
CM08	small	€ 97	1	0.00	0
CM09	large	€ 128	1	0.00	0



CM10

version	dimensions	fabric	transport information		
		fabric	colli	m3	kg
CM10	small	€ 49	1	0.00	0
CM11	medium	€ 67	1	0.00	0
CM12	large	€ 79	1	0.00	0



CM13

version	dimensions	fabric	transport information		
		fabric	colli	m3	kg
CM13	short	€ 97	1	0.00	0
CM14	long	€ 128	1	0.00	0

3 Materials

-

4 Finishes

For an overview of all current Arco colors, please refer to this price list page 5 ff or visit our website www.arco.nl.

product

1 **CM08/09**
CM10/11/12
CM13/14

5 **Additional information**

-

Ordering support

type
size
color

example
cable sock
small
black

1 CM04

2 Standard

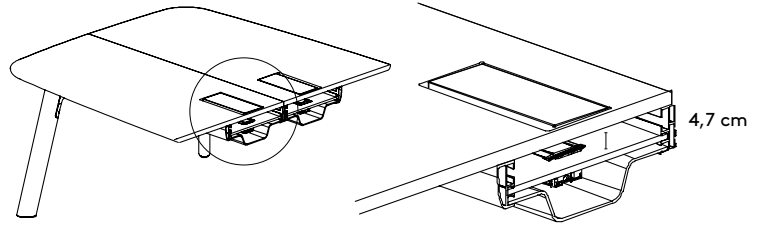
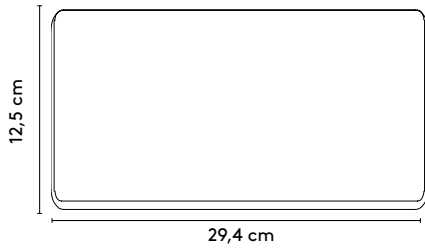

3 Materials

Cable lid
oak or walnut (solid, veneer)

Materialen

Kabel klep
eiken of noten (massief, fineer)

Materialien

Kabel Deckung
Eiche oder Nussbaum (massiv, furnier)

4 Finishes

All Arco colors and finishes for the mentioned materials

Afwerkingen

Alle Arco kleuren en (lak)afwerkingen voor de genoemde materialen

Ausführungen

Alle Arco Farben und Ausführungen für die genannten Materialien

5 Additional information

Standard with EVoline® FrameDock, max 4 modules.

Not applicable on the seam of 2 table tops.

Aanvullende informatie

Standaard met EVoline® FrameDock, max 4 modules.

Niet toepasbaar op de naad van 2 bladen.

Weitere Informationen

Standard mit EVoline® FrameDock, max 4 Module.

Nicht möglich auf der Naht von 2 Tischplatten.

6 Cable management



CM10/CM11/CM12
cable sock
medium



CM13
zipper sock

7 Electrification



CM15
EVoline® One spot
Ø 5,9 cm

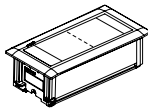

EVoline®
FrameDock
2 - 3 modules



Power
module



RJ45
module



HDMI
module



USB
charger
module

product

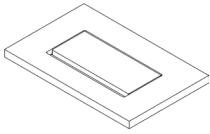
1 **CM04**2a **Standard**CM04

version	dimensions	oak		walnut		transport information		
		veneer	solid	veneer	solid	colli	m3	kg
CM04	30x10cm	€ 708	€ 612	€ 708	€ 612	0	0.00	0

3 **Materials**

-

4 **Finishes**

For an overview of all current Arco colors, please refer to this price list page 5 ff or visit our website www.arco.nl.

5 **Additional information**

Please indicate the desired position of the cable box on the order.

6 **Cable management**

CM10	CM11	CM12	CM13	CM14
€ 49	€ 67	€ 79	€ 97	€ 128

7 **Elektrificatie**

Evoline frame dock (black, incl. cable with GST18) including mounting	€ 315
Power module (WCD, black)	€ 30
Data connection module RJ45 (half, black)	€ 48
HDMI module (half, black)	€ 85
USB charger (half, black)	€ 48

Ordering support

	example
type	CM04
position kabelbox	indicate on drawing
material cable lid	solid oak
color cable lid	1301 - carbon
finish cable lid	P-lacquer
electrification?	yes
modules	2 x WCD, 1 x HDMI and 1x USB
material inlay cable box	oak veneer
color inlay cable box	1301 - carbon
country code	NL

1 CM05

2 Standard

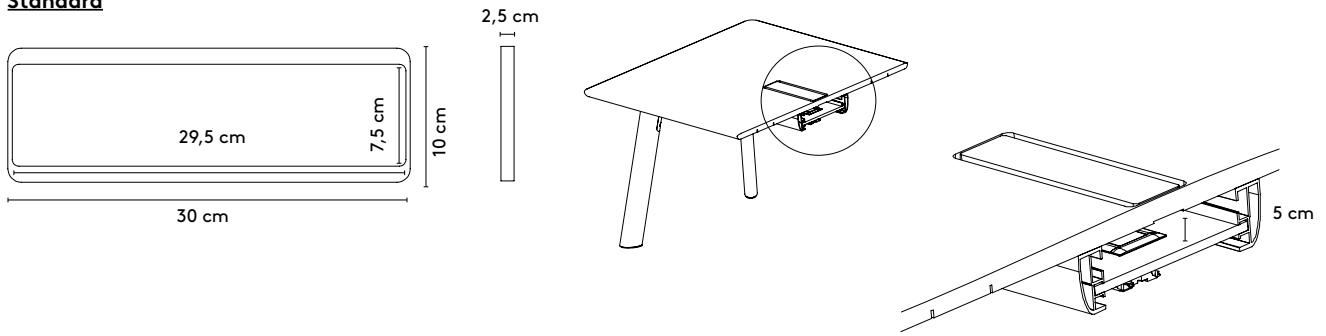

3 Materials

Cable lid
oak or walnut (solid, veneer)

Materialen

Kabel klep
eiken of noten (massief, finer)

Materialien

Kabel Deckung
Eiche oder Nussbaum (massiv, furnier)

4 Finishes

All Arco colors and finishes for the mentioned materials

Afwerkingen

Alle Arco kleuren en (lak)afwerkingen voor de genoemde materialen

Ausführungen

Alle Arco Farben und Ausführungen für die genannten Materialien

5 Additional information

Standard with EVOLine® FrameDock, max 4 modules.

Not applicable on the seam of 2 table tops.

Aanvullende informatie

Standaard met EVOLine® FrameDock, max 4 modules.

Niet toepasbaar op de naad van 2 bladen.

Weitere Informationen

Standard mit EVOLine® FrameDock, max 4 Module.

Nicht möglich auf der Naht von 2 Tischplatten.

6 Cable management

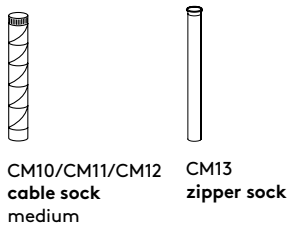

CM10/CM11/CM12
cable sock
medium

CM13
zipper sock

7 Electrification

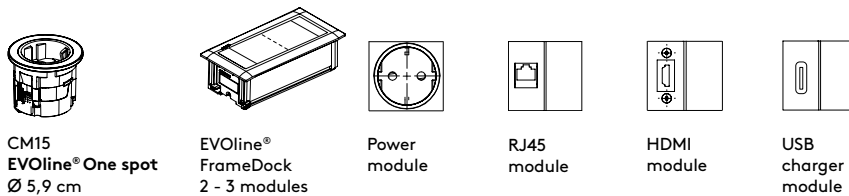

CM15
EVOLine® One spot
Ø 5,9 cm

EVOLine®
FrameDock
2 - 3 modules

Power
module

RJ45
module

HDMI
module

USB
charger
module

product

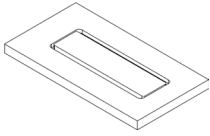
1 **CM05**2a **Standard**CM05

version	dimensions	oak		walnut		transport information		
		veneer	solid	veneer	solid	colli	m3	kg
CM05	30x10cm	€ 660	€ 612	€ 660	€ 612	0	0.00	0

3 **Materials**

-

4 **Finishes**

For an overview of all current Arco colors, please refer to this price list page 5 ff or visit our website www.arco.nl.

5 **Additional information**

Please indicate the desired position of the cable box on the order.

6 **Cable management**

CM10	CM11	CM12	CM13
€ 49	€ 67	€ 79	€ 97

7 **Elektrificatie**

Evoline frame dock (black, incl. cable with GST18) including mounting	€ 315
Power module (WCD, black)	€ 30
Data connection module RJ45 (half, black)	€ 48
HDMI module (half, black)	€ 85
USB charger (half, black)	€ 48

Ordering support

	example
type	CM05
position kabelbox	indicate on drawing
material cable lid	solid oak
color cable lid	1500 - moss
finish cable lid	P-lacquer
electrification?	yes
modules	2 x WCD, 1 x HDMI and 1x USB
material inlay cable box	oak veneer
color inlay cable box	1500 - moss
country code	BE

1 CM06 (small) / CM07 (large)

2 Standard

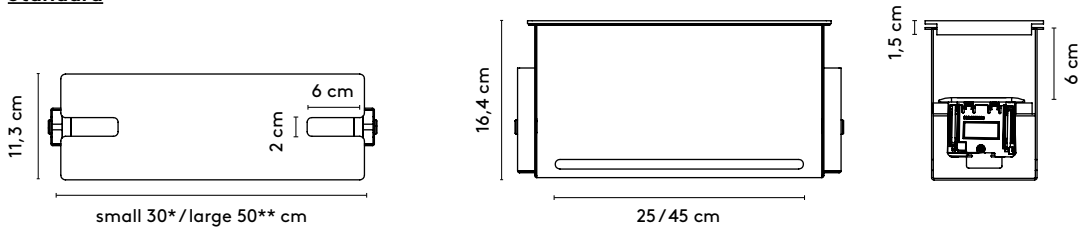

3 Materials

Cable lid
oak (solid)

Cable box
epoxy fine texture (RAL9005, RAL9010)

Inlay cable box
oak (veneer)

Materialen

Kabel klep
eiken (massief)

Kabel box
epoxy fine texture (RAL9005, RAL9010)

Inlay kabel box
eiken (fineer)

Materialien

Kabel Deckung
Eiche (massiv)

Kabel Box
Epoxy fine texture (RAL9005, RAL9010)

Inlay Kabel Box
Eiche (furnier)

4 Finishes

All Arco colors and finishes for the mentioned materials

Afwerkingen

Alle Arco kleuren en (lak)afwerkingen voor de genoemde materialen

Ausführungen

Alle Arco Farben und Ausführungen für die genannten Materialien

5 Additional information

Standard with EVOLine® FrameDock
* Up to 3 modules
** Up to 7 modules

Aanvullende informatie

Standaard met EVOLine® FrameDock
* Maximaal 3 modules
** Maximaal 7 modules

Weitere Informationen

Standard mit EVOLine® FrameDock
* Maximum 3 Module
** Maximum 7 Module

6 Cable management

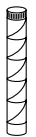

CM10/CM11/CM12
cable sock



CM13/CM14
zipper sock

7 Electrification



CM15
EVOLine® One spot
Ø 5,9 cm

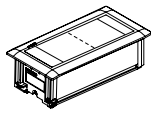

EVOLine®
FrameDock
2 - 3 modules



Power
module



RJ45
module



HDMI
module



USB
charger
module

product

1 CM06 (small) / CM07 (large)

2a Standard



CM06

version	dimensions	CM06	CM07	transport information		
				oak	oak	colli
CM06	30x10cm	€ 545		1	0.01	2
CM07	50x10cm		€ 587	1	0.01	2

3 Materials

-

4 Finishes

For an overview of all current Arco colors, please refer to this price list page 5 ff or visit our website www.arco.nl.

5 Additional information

Please indicate the desired position of the cable box on the order.

6 Cable management

CM10 € 49	CM11 € 67	CM12 € 79	CM13 € 97	CM14 € 128
--------------	--------------	--------------	--------------	---------------

7 Elektrificatie

Evoline frame dock (black, incl. cable with GST18) including mounting	€ 315
Power module (WCD, black)	€ 30
Data connection module RJ45 (half, black)	€ 48
HDMI module (half, black)	€ 85
USB charger (half, black)	€ 48

Ordering support

	example
type	CM06
position kabelbox	indicate on drawing
color kabelbox	5100 - RAL 9010 white
material cable lid	solid oak
color cable lid	1100 - natural
finish cable lid	P-lacquer
electrification?	yes
modules	2 x WCD, 1 x HDMI and 1x USB
material inlay cable box	oak veneer
color inlay cable box	1100 - natural
country code	DE

1 CM15

2 **Standard**

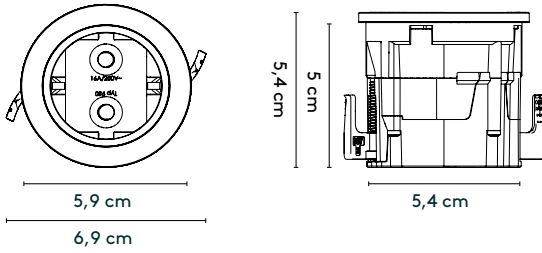

3 **Materials**

-

Materialen

-

Materialien

-

4 **Finishes**

-

Afwerkingen

-

Ausführungen

-

Additional information

5 **Version as EVOLine® One Spot
Up to 4 spots per table top**

Aanvullende informatie

Uitgevoerd als EVOLine® One Spot
Maximaal 4 spots per blad

Weitere Informationen

Ausgeführt als EVOLine® One Spot
Maximum 4 Spots pro Tischplatte

6 **Cable management**



CM10/CM11/CM12
cable sock



CM13/CM14
zipper sock

7 **Electrification**



Power



RJ45



HDMI



USB
charger

product

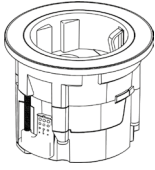
1 **CM15**2a **Standard**

CM15

version	dimensions	CM15	transport information		
		startup costs	colli	m3	kg
CM15	EVOLine® One spot	€ 152	0	0.00	0

3 **Materials**

-

4 **Finishes**

-

5 **Additional information**

There is a one-time start-up price of € 152 (gross incl. VAT), regardless of the amount of spots chosen. Please indicate the desired position of the spot(s) on the order.

6 **Cable management**

CM10	CM11	CM12	CM13	CM14
€ 49	€ 67	€ 79	€ 97	€ 128

7 **Elektrificatie**

EVOLine® One spot (black, incl. cable)	€ 152
start-up price regardless of amount of spots and including mounting	
Power module (WCD, black)	€ 91
USB-A + USB-C charger module (black)	€ 169
USB-A 3.0 module (half, black)	€ 139
USB-C module (half, black)	€ 139
RJ45 CAT6 module (half, black)	€ 139
RJ45 CAT6a module (half, black)	€ 139
HDMI module (half, black)	€ 169
HDMI 2.0 + RJ45 CAT6 module (black)	€ 169

Ordering support

example

type	CM15
position spot(s)	indicate on drawing
electrification?	yes
modules	2 x WCD, 1 x HDMI and 1x USB
country code	NL

1 CM16

2 Standard

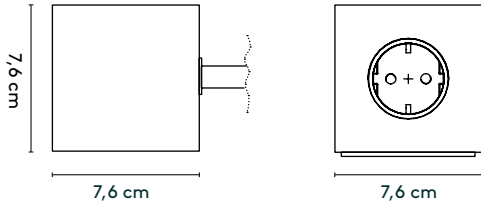

3 Materials

Enclosure
Zinc aluminum alloy and plastic
(PC, ABS) (20% recycled)

Materialen

Behuizing
Zink aluminiumlegering en plastic
(PC, ABS) (20% gerecycled)

Materialien

Gehege
Zink-Aluminium-Legierung und Kunststoff
(PC, ABS) (20 % recycelt)

4 Finishes

Colors
Stockholm Black

Afwerkingen

Kleuren
Stockholm Black

Ausführungen

Farben
Stockholm Black

5 Additional information

Version as Avolt Square 1

Aanvullende informatie

Uitgevoerd als Avolt Square 1

Weitere Informationen

Ausgeführt als Avolt Square 1

6 Cable management

-

Cable management

-

Cable management

-

7 Electrification

Plug & socket type : 3x Schuko Type F
USB type: 2x USB Type A

Electrification

Stekker & stopcontact type : 3x Schuko Type F
USB-type: 2x USB Type A

Electrification

Stecker- und Steckdosentyp: 3x Schuko Typ F
USB-Typ: 2x USB Typ A

product

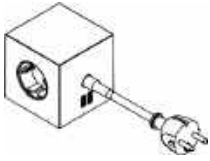
1 **CM16**2a **Standard**

CM16

		CM16	transport information		
version	dimensions	CM16	colli	m3	kg
CM16	Avolt Square 1	€ 67	0	0.00	0

3 **Materials**

-

4 **Finishes**

-

5 **Additional information**

-

6 **Cable management**

€ 67

7 **Elektrificatie**

-

Ordering support

example

type
color
country code

CM16
Stockholm Black
NL

Seating & Low seating

p. 129 **Information**
p. 130 **Arc**
p. 30 **Base Bench**
p. 132 **Bock**
p. 134 **Close**
p. 140 **Ease**
p. 44 **Essenza Bench**
p. 142 **Frame**
p. 142 **Frame Friendly**
p. 146 **Home-Work**
p. 148 **Laze**
p. 150 **Re-volve**
p. 152 **Side by Side**
p. 156 **Sketch Office**
p. 162 **Sketch Regular**
p. 86 **Slim Bench**
p. 92 **Slim+ Bench**

we create comfort

Information

Most Arco chairs are available in a large number of fabric and leather types. Almost all Kvadrat, Febrik and De Ploeg fabrics are suitable for our chairs (with the exception of Home-Work and Side by Side).

The price classification of frequently used fabrics and the Arco leather collection can be found in our fabric list. This can be found on our website.

If the fabric you have chosen is not listed, please contact our sales department. In connection with the processability of the fabric, you may be

asked to send a sample to determine whether or not a fabric is suitable.

Orders for which you send the fabric yourself will not be processed and confirmed until we have received the fabric.

For leather, in addition to the Arco leather collection, a choice can be made from the Ohmann 1012 and 1010 collection. For these qualities, a minimum purchase quantity of 4 chairs in the same version then applies.

See www.arco.nl for the current fabric list.

product

designer

year

1 Arc

Bertjan Pot

2008

2 Standard

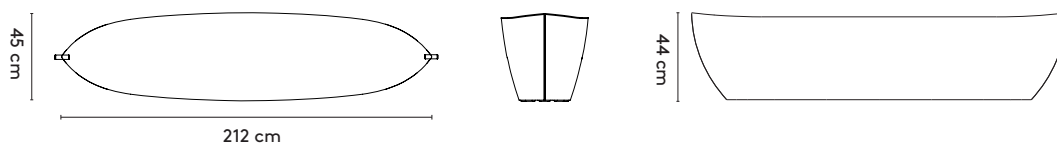

3 Materials

Top: oak (solid)
Body: oak (veneer)
Straps: leather brown

Materialen

Blad: eiken (massief)
Romp: eiken (fineer)
Grepen: leder brown

Materialien

Platte: Eiche (Massiv)
Korpus: Eiche (Furnier)
Trageschlaufen: Leder brown

4 Finishes

Only possible in the Arco colors 1202 morado, 1300 black or 1301 carbon, and all finishes for the mentioned materials

Afwerkingen

Alleen mogelijk in de Arco kleuren 1202 morado, 1300 black of 1301 carbon, en alle afwerkingen voor de genoemde materialen

Ausführungen

Nur in den Arco Farben 1202 morado, 1300 black oder 1301 carbon, und alle Ausführungen für die genannten Materialien

5 Additional information

-

Aanvullende informatie

-

Weitere Informationen

-

product

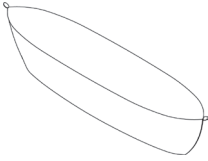
1 **Arc**2 **Standard**Arc

	oak	transport information		
version	oak	colli	m3	kg
Arc	€ 4635	1	0.50	26

3 **Materials**

-

4 **Finishes**

For an overview of all current Arco colors, please refer to this price list page 5 ff or visit our website www.arco.nl.

5 **Additional information**

-

Ordering support

type
color
finish
color straps

example

Arc
1202 - morado
N-lacquer
brown

product

designer

year

1 **Bock**

**Carolin
Zeyher**

2020

2 **Standard**

Bock

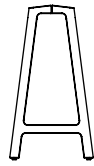
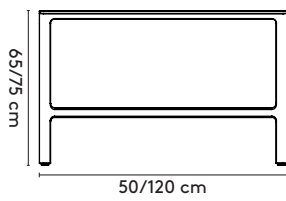

Tablet

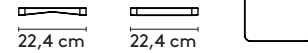

50x41x65/75 cm (1 seater)
120x41x65/75 cm (2 seater)

22,4x22,4 cm

3 **Materials**

Seat: oak (solid)
Footrest: black plastic foot strip

Materialen

Zitting: eiken (massief)
Voetensteun: zwarte kunststof strip

Materialien

Sitz: Eiche (Massiv)
Füßsstütze: schwarzer kunststoff Streifen

4 **Finishes**

All Arco colors and finishes for the mentioned materials

Afwerkingen

Alle Arco kleuren en (lak)afwerkingen voor de genoemde materialen

Ausführungen

Alle Arco Farben und Ausführungen für die genannten Materialien

5 **Additional information**

-

Aanvullende informatie

-

Weitere Informationen

-

product

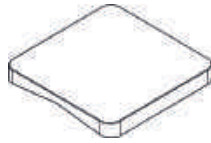
1 **Bock**2 **Standard**

Bock

Bock tablet

version	dimensions	oak	transport information		
		solid	colli	m3	kg
Bock	50x41x65cm	€ 1017	1	0.20	6
Bock	50x41x75cm	€ 1017	1	0.20	6
Bock	120x41x65 cm	€ 1416	1	0.40	14
Bock	120x41x75 cm	€ 1416	1	0.40	14
Bock tablet	22,4x22,4cm	€ 152	1	0.01	1

3 **Materials**

-

4 **Finishes**

For an overview of all current Arco colors, please refer to this price list page 5 ff or visit our website www.arco.nl.

5 **Additional information**

-

Ordering support

type
width
height
color
finish

example

Bock
120cm
65cm
1300 - black
N-lacquer

1 **Close**

Gudmundur Ludvik

2016 - 2022

2 **Standard**

Close 1

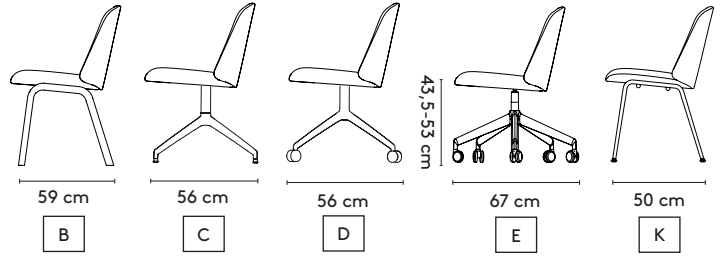
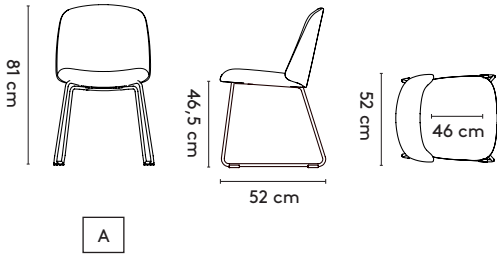

Close 2

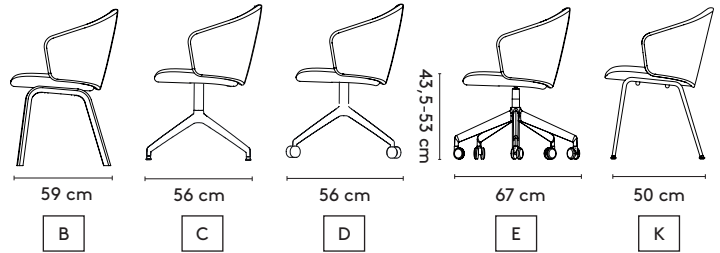
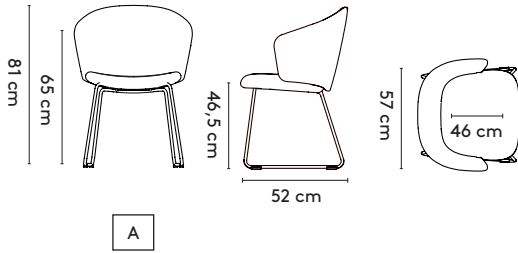

Close+ 2

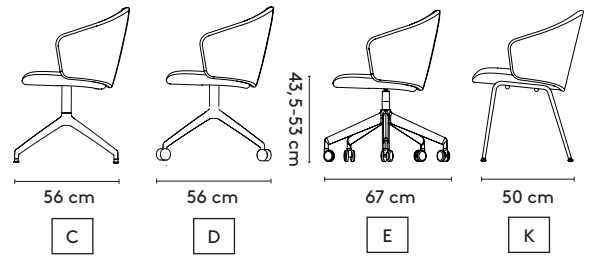
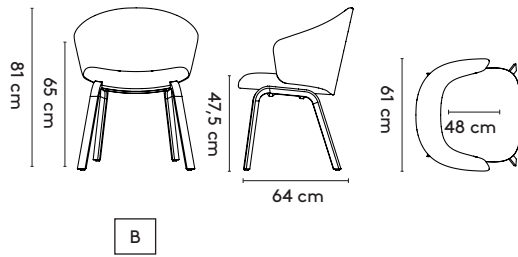

Close lounge

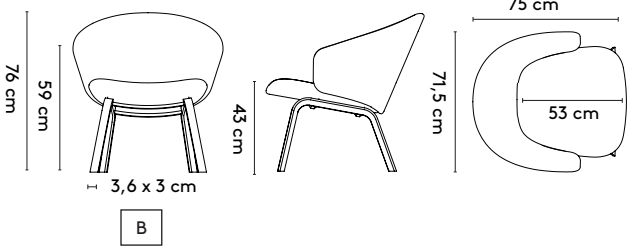

Close barstool

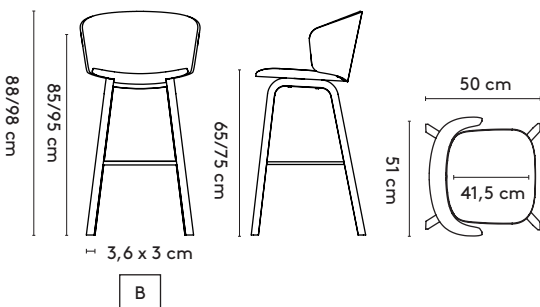

1 **Close**

Close bench

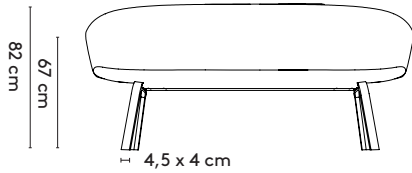
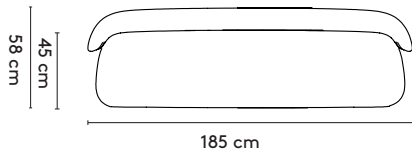

B

130 x 58 x 82 cm
185 x 58 x 82 cm
240 x 58 x 82 cm

Close bench connected

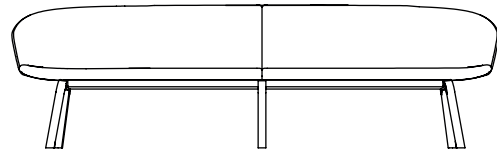
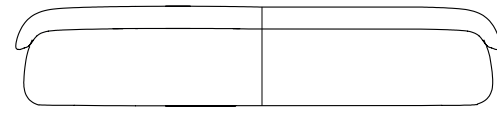

316 cm

316 x 58 x 82 cm (6 legs)
426 x 58 x 82 cm (6 legs)

3 **Materials**

Seat: fabric or leather

Frame:

A. cantilever: epoxy fine texture on steel

B. beech laminate with oak or walnut top layer

C. 4 feet central base (swivel) on feet: polished aluminum, epoxy fine texture on aluminum

D. 4 feet central base (fixed) on castors: polished aluminum, epoxy fine texture on aluminum

E. 5 feet central base (swivel, height adjustable) on castors: polished aluminum, epoxy fine texture on aluminum

K. leg conical: epoxy fine texture on steel

Materialen

Kuijp: stof of leder

Onderstel:

A. slede: epoxy fine texture op staal

B. beuken laminaat met eiken of noten toplaag

C. 4 teens centrale voet (draaibaar) op pootjes: gepolijst aluminium, epoxy fine texture op aluminium

D. 4 teens centrale voet (vast) op wielen: gepolijst aluminium, epoxy fine texture op aluminium

E. 5 teens centrale voet (draaibaar met gasveer) op wielen: gepolijst aluminium, epoxy fine texture op aluminium

K. poot conisch: epoxy fine texture op staal

Materialien

Sitz: Stoff oder Leder

Untergestell:

A. Kufen: Epoxy fine texture auf Stahl

B. Buche Laminat mit Eiche oder Nussbaum Oberbeschichtung

C. 4 Bein Zentralfuss (drehbar) auf Füße: poliertes Aluminium, Epoxy fine texture auf Aluminium

D. 4 Bein Zentralfuss (fest) auf Rollen: poliertes Aluminium, Epoxy fine texture auf Aluminium

E. 5 Bein Zentralfuss (drehbar mit Gasfeder) auf Rollen: poliertes Aluminium, Epoxy fine texture auf Aluminium

K. Bein konisch: Epoxy fine texture auf Stahl

4 **Finishes**

All Arco colors and only N- or P-lacquer finishes for the mentioned materials

Afwerkingen

Alle Arco kleuren en alleen N- of P-lak voor de genoemde materialen

Ausführungen

Alle Arco Farben und nur N- oder P-lack Ausführungen für die genannte Materialien

5 **Additional information**

-

Aanvullende informatie

-

Weitere Informationen

-

product

1 **Close**2 **Standard**Close 1 AClose 1 BClose 1 CClose 1 DClose 1 EClose 1 K

version	material frame	fabric							leather				transport information		
		fabric group basic	fabric group 1	fabric group 2	fabric group 3	fabric group 4	fabric group 5	COM	leather group a	leather group b	leather group c	leather group d	colli	m3	kg
Close 1 A		€ 539	€ 599	€ 648	€ 690	€ 702	€ 733	€ 599	€ 745	€ 878	€ 962	€ 999	1	0.38	7
Close 1 B	oak	€ 575	€ 642	€ 696	€ 726	€ 781	€ 902	€ 642	€ 781	€ 914	€ 1005	€ 1029	1	0.38	7
Close 1 B	walnut	€ 636	€ 696	€ 751	€ 787	€ 847	€ 968	€ 696	€ 847	€ 975	€ 1071	€ 1102	1	0.38	7
Close 1 C		€ 739	€ 787	€ 847	€ 890	€ 944	€ 1065	€ 787	€ 944	€ 1077	€ 1156	€ 1198	1	0.38	7
Close 1 D		€ 739	€ 787	€ 847	€ 890	€ 944	€ 1065	€ 787	€ 944	€ 1077	€ 1156	€ 1198	1	0.38	7
Close 1 E		€ 829	€ 890	€ 938	€ 975	€ 1029	€ 1150	€ 890	€ 1029	€ 1168	€ 1253	€ 1289	1	0.38	7
Close 1 K		€ 575	€ 642	€ 696	€ 726	€ 781	€ 902	€ 642	€ 781	€ 914	€ 1005	€ 1029	1	0.38	7

Close 2 AClose 2 BClose 2 CClose 2 DClose 2 EClose 2 K

version	material frame	fabric							leather				transport information		
		fabric group basic	fabric group 1	fabric group 2	fabric group 3	fabric group 4	fabric group 5	COM	leather group a	leather group b	leather group c	leather group d	colli	m3	kg
Close 2 A		€ 636	€ 654	€ 702	€ 787	€ 847	€ 890	€ 654	€ 872	€ 993	€ 1035	€ 1132	1	0.38	9
Close 2 B	oak	€ 672	€ 702	€ 745	€ 829	€ 890	€ 932	€ 702	€ 908	€ 1023	€ 1077	€ 1180	1	0.38	9
Close 2 B	walnut	€ 726	€ 745	€ 799	€ 896	€ 944	€ 1011	€ 757	€ 975	€ 1096	€ 1156	€ 1259	1	0.38	9
Close 2 C		€ 829	€ 860	€ 902	€ 975	€ 1035	€ 1096	€ 860	€ 1071	€ 1186	€ 1235	€ 1350	1	0.38	10
Close 2 D		€ 829	€ 860	€ 902	€ 975	€ 1035	€ 1096	€ 860	€ 1071	€ 1186	€ 1235	€ 1350	1	0.38	10
Close 2 E		€ 914	€ 944	€ 993	€ 1077	€ 1132	€ 1180	€ 944	€ 1156	€ 1277	€ 1325	€ 1440	1	0.38	10
Close 2 K		€ 672	€ 702	€ 745	€ 829	€ 890	€ 932	€ 702	€ 908	€ 1023	€ 1077	€ 1180	1	0.38	9

Close+ 2 BClose+ 2 CClose+ 2 DClose+ 2 EClose+ 2 K

version	material frame	fabric							leather				transport information		
		fabric group basic	fabric group 1	fabric group 2	fabric group 3	fabric group 4	fabric group 5	COM	leather group a	leather group b	leather group c	leather group d	colli	m3	kg
Close+ 2 B	oak	€ 787	€ 835	€ 920	€ 962	€ 1047	€ 1223	€ 835	€ 1102	€ 1301	€ 1465	€ 1580	1	0.38	9
Close+ 2 B	walnut	€ 860	€ 902	€ 999	€ 1041	€ 1120	€ 1301	€ 902	€ 1186	€ 1392	€ 1567	€ 1682	1	0.38	9
Close+ 2 C		€ 938	€ 993	€ 1077	€ 1114	€ 1204	€ 1374	€ 993	€ 1259	€ 1452	€ 1616	€ 1731	1	0.38	10
Close+ 2 D		€ 938	€ 993	€ 1077	€ 1114	€ 1204	€ 1374	€ 993	€ 1259	€ 1452	€ 1616	€ 1731	1	0.38	10
Close+ 2 E		€ 1029	€ 1071	€ 1168	€ 1204	€ 1283	€ 1452	€ 1071	€ 1350	€ 1543	€ 1707	€ 1822	1	0.38	10
Close+ 2 K		€ 787	€ 835	€ 920	€ 962	€ 1047	€ 1223	€ 835	€ 1102	€ 1301	€ 1465	€ 1580	1	0.38	9

product

1 **Close**2 **Standard**Close lounge BClose lounge C

version	material frame	fabric							COM	leather				transport information		
		fabric group basic	fabric group 1	fabric group 2	fabric group 3	fabric group 4	fabric group 5	leather group a		leather group b	leather group c	leather group d	colli	m3	kg	
Close lounge B	oak	€ 908	€ 1023	€ 1174	€ 1247	€ 1374	€ 1628	€ 1023	€ 1217	€ 1507	€ 1725	€ 1791	1	0.40	11	
Close lounge B	walnut	€ 975	€ 1096	€ 1259	€ 1331	€ 1459	€ 1737	€ 1096	€ 1289	€ 1604	€ 1828	€ 1912	1	0.40	11	
Close lounge C		€ 1059	€ 1174	€ 1319	€ 1392	€ 1525	€ 1779	€ 1174	€ 1374	€ 1664	€ 1876	€ 1943	1	0.40	11	

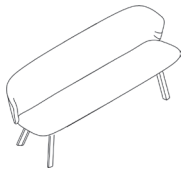
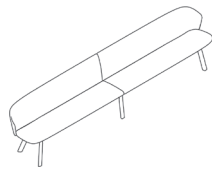
Close bench BClose bench connected

version	dimensions / frame	fabric							COM	leather				transport information		
		fabric group basic	fabric group 1	fabric group 2	fabric group 3	fabric group 4	fabric group 5	leather group a		leather group b	leather group c	leather group d	colli	m3	kg	
Close bench B	130x58x82cm oak	€ 2475	€ 2529	€ 2669	€ 2898	€ 3086	€ 3340	€ 2529	€ 2868	€ 3292	€ 3564	€ 3715	1	0.50	16	
Close bench B	130x58x82cm walnut	€ 2626	€ 2687	€ 2826	€ 3062	€ 3274	€ 3528	€ 2687	€ 3038	€ 3479	€ 3770	€ 3927	1	0.50	16	
Close bench B	185x58x82cm oak	€ 2590	€ 2699	€ 2874	€ 3159	€ 3358	€ 3703	€ 2699	€ 3104	€ 3721	€ 4187	€ 4320	1	0.70	23	
Close bench B	185x58x82cm walnut	€ 2741	€ 2856	€ 3050	€ 3340	€ 3546	€ 3909	€ 2856	€ 3286	€ 3933	€ 4429	€ 4550	1	0.70	23	
Close bench B	240x58x82cm oak	€ 2850	€ 3007	€ 3225	€ 3540	€ 3745	€ 4217	€ 3007	€ 3509	€ 4308	€ 4949	€ 5167	1	0.90	30	
Close bench B	240x58x82cm walnut	€ 3019	€ 3183	€ 3407	€ 3739	€ 3957	€ 4453	€ 3183	€ 3709	€ 4544	€ 5210	€ 5445	1	0.90	30	
Close bench connected	316x58x82cm oak	€ 4683	€ 5040	€ 5476	€ 5881	€ 6280	€ 7224	€ 5040	€ 5464	€ 6964	€ 7121	€ 7369	2	1.90	33	
Close bench connected	316x58x82cm walnut	€ 4961	€ 5331	€ 5784	€ 6208	€ 6625	€ 7617	€ 5331	€ 5772	€ 7351	€ 7515	€ 7769	2	1.90	33	
Close bench connected	426x58x82cm oak	€ 5645	€ 6299	€ 6801	€ 7357	€ 7950	€ 9366	€ 6299	€ 6637	€ 8283	€ 9015	€ 9378	2	2.60	56	
Close bench connected	426x58x82cm walnut	€ 5960	€ 6649	€ 7176	€ 7757	€ 8392	€ 9868	€ 6649	€ 7000	€ 8737	€ 9505	€ 9880	2	2.60	56	

product

1 Close

2 Standard



Close barstool

version	height/ frame	fabric							leather				transport information		
		fabric group basic	fabric group 1	fabric group 2	fabric group 3	fabric group 4	fabric group 5	COM	leather group a	leather group b	leather group c	leather group d	colli	m3	kg
Close barstool	oak H65	€ 835	€ 896	€ 938	€ 1023	€ 1083	€ 1198	€ 896	€ 1102	€ 1217	€ 1253	€ 1368	1	0.60	11
Close barstool	oak H75	€ 835	€ 896	€ 938	€ 1023	€ 1083	€ 1198	€ 896	€ 1102	€ 1217	€ 1253	€ 1368	1	0.60	11
Close barstool	walnut H65	€ 926	€ 999	€ 1047	€ 1120	€ 1198	€ 1301	€ 999	€ 1210	€ 1325	€ 1374	€ 1489	1	0.60	11
Close barstool	walnut H75	€ 926	€ 999	€ 1047	€ 1120	€ 1198	€ 1301	€ 999	€ 1210	€ 1325	€ 1374	€ 1489	1	0.60	11

3 Materials

For a current list of all possible fabrics and their classification in fabric groups, consult the list of fabrics and leathers on our website www.arco.nl.

4 Finishes

For an overview of all current Arco colors, please refer to this price list page 5 ff or visit our website www.arco.nl.

5 Additional information

Duo upholstery possible (seat other fabric/leather): price entirely in the most expensive fabric/leather + surcharge € 50 per chair (gross incl. VAT).

Close 1

COM: 1,1 gross of plain fabric, minimum width 130 cm per chair.

Close 2

COM: 1,3 gross of plain fabric, minimum width 130 cm per chair.

Close+ 2

COM: 1,6 gross of plain fabric, minimum width 130 cm per chair.

Close Lounge

COM: 2,0 gross of plain fabric, minimum width 130 cm per chair.

Close Barstool

COM: 0,85 gross of plain fabric, minimum width 130 cm per chair.

Close Bench

COM: 3,2/4,3/5,5/7,0/8,8 gross of plain fabric, minimum width 130 cm per bench.

Ordering support

type	example
material seat	Close 1 B
color seat	Remix
color frame	133
finish frame	30
	N-lacquer

product

designer

year

1 Ease

Burkhard Vogtherr & Jonathan Prestwich

2013

2 Standard

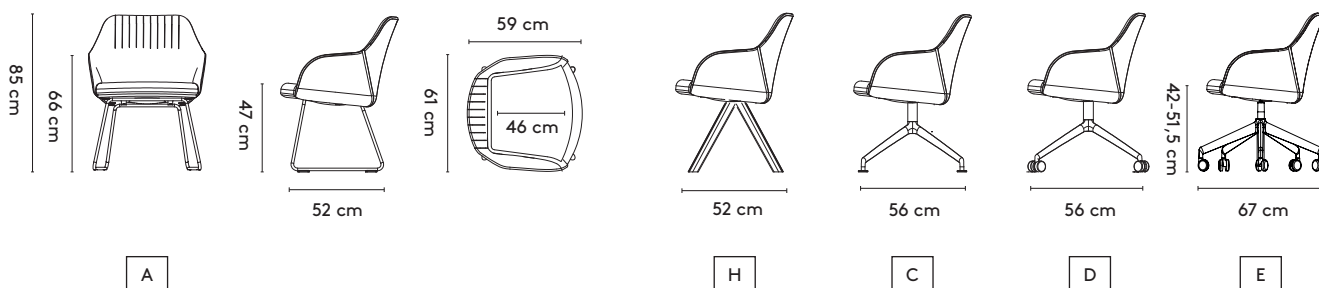

3 Materials

Seat: upholstered (fabric, leather)
Frame:
A. Cantilever: epoxy fine texture on steel

H. 4 legs (fixed, swivel): oak (solid)

C. 4 feet central base (swivel) on feet: polished aluminum, epoxy fine texture on aluminum

D. 4 feet central base (fixed) on castors: polished aluminum, epoxy fine texture on aluminum

E. 5 feet central base (swivel, height adjustable) on castors: polished aluminum, epoxy fine texture on aluminum

Materialen

Kuip: gestoffeerd (stof, leer)
Onderstel:
A. Slede: epoxy fine texture op staal

H. 4 poten (vast of draaibaar): eiken (massief)

C. 4 teens centrale voet (draaibaar) op pootjes: gepolijst aluminium, epoxy fine texture op aluminium

D. 4 teens centrale voet (vast) op wielen: gepolijst aluminium, epoxy fine texture op aluminium

E. 5 teens centrale voet (draaibaar met gasveer) op wielen: gepolijst aluminium, epoxy fine texture op aluminium

Materialien

Sitzschale: gepolstert (Stoff, Leder)
Untergestell:
A. Kufen: Epoxy fine texture auf Stahl

H. 4 Beine (fest oder drehbar): Eiche (Massiv)

C. 4 Bein Zentralfuss (drehbar) auf Füße: poliertes Aluminium, Epoxy fine texture auf Aluminium

D. 4 Bein Zentralfuss (fest) auf Rollen: poliertes Aluminium, Epoxylack auf Aluminium, Epoxy fine texture auf Aluminium

E. 5 Bein Zentralfuss (drehbar mit Gasfeder) auf Rollen: poliertes Aluminium, Epoxylack auf Aluminium, Epoxy fine texture auf Aluminium

4 Finishes

All Arco colors and only N- or P-lacquer finishes for the mentioned materials

Afwerkingen

Alle Arco kleuren en alleen N- of P-lak voor de genoemde materialen

Ausführungen

Alle Arco Farben und nur N- oder P-lack Ausführungen für die genannte Materialien

5 Additional information

-

Aanvullende informatie

-

Weitere Informationen

-

product

1 **Ease**2 **Standard**

Ease A



Ease H



Ease C



Ease D



Ease E

version	frame	fabric							leather				transport information		
		fabric group basic	fabric group 1	fabric group 2	fabric group 3	fabric group 4	fabric group 5	COM	leather group a	leather group b	leather group c	leather group d	colli	m3	kg
Ease A	Ease A	€ 835	€ 914	€ 993	€ 1035	€ 1259	€ 1331	€ 914	€ 1235	€ 1313	€ 1513	€ 1646	1	0.32	11
Ease H	Ease H fixed	€ 962	€ 1035	€ 1114	€ 1156	€ 1386	€ 1452	€ 1035	€ 1350	€ 1440	€ 1646	€ 1773	1	0.32	12
Ease H	Ease H swivel	€ 1035	€ 1102	€ 1192	€ 1229	€ 1459	€ 1519	€ 1102	€ 1440	€ 1513	€ 1725	€ 1846	1	0.32	12
Ease C	Ease C	€ 1035	€ 1102	€ 1192	€ 1229	€ 1459	€ 1519	€ 1102	€ 1440	€ 1513	€ 1725	€ 1846	1	0.32	12
Ease D	Ease D	€ 1035	€ 1102	€ 1192	€ 1229	€ 1459	€ 1519	€ 1102	€ 1440	€ 1513	€ 1725	€ 1846	1	0.32	12
Ease E	Ease E	€ 1114	€ 1198	€ 1283	€ 1313	€ 1543	€ 1622	€ 1198	€ 1513	€ 1610	€ 1815	€ 1936	1	0.32	12

3 **Materials**

For a current list of all possible fabrics and their classification in fabric groups, consult the list of fabrics and leathers on our website www.arco.nl.

4 **Finishes**

For an overview of all current Arco colors, please refer to this price list page 5 ff or visit our website www.arco.nl.

5 **Additional information**

Duo upholstery possible (seat other fabric/leather): price entirely in the most expensive fabric/leather + surcharge € 50 per chair (gross incl. VAT).

COM: 3,6 gross of plain fabric, minimum width 130 cm for 2 chairs (minimum order quantity).

Ordering support

type
material seat
color seat
material frame
color frame
finish frame

example

Ease D
Steelcut trio
153
alu
5200 - grey
epoxy fine texture

1 **Frame****Burkhard
Vogtherr**

2000 - 2024

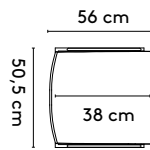
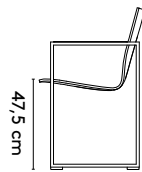
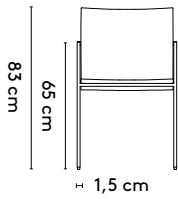
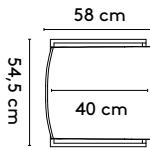
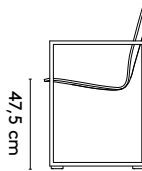
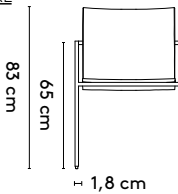
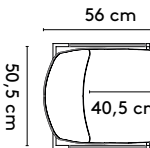
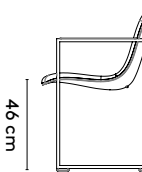
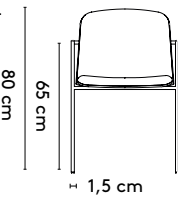
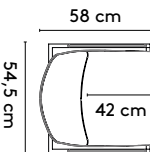
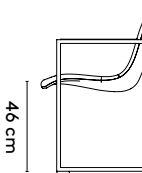
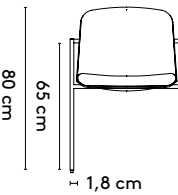
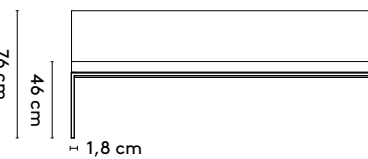
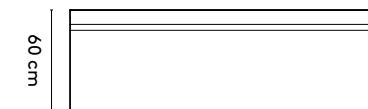
2 **Standard**FrameFrame XLFrame IIFrame II XLFrame bench

150 x 60 x 76 cm
180 x 60 x 76 cm
210 x 60 x 76 cm
240 x 60 x 76 cm

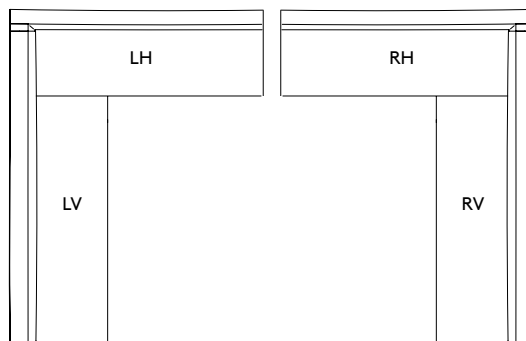

LV 150/180/210/240 cm
LH 150/180/210/240 cm

RV 150/180/210/240 cm
RH 150/180/210/240 cm

3 **Materials**

Seat: upholstered (fabric, leather, fabric Celia only for Frame Friendly) or oak (veneer, only available for Frame, not Frame II)
Frame: mat chrome, epoxy fine texture on steel (Frame Friendly only in black)

Materialen

Zitting: gestoffeerd (stof, leder, stof Celia alleen bij Frame Friendly) of eiken (fineer, alleen mogelijk voor Frame, niet voor Frame II)
Onderstel: parelchrom, epoxy fine texture op staal (Frame Friendly alleen in zwart)

Materialien

Sitz: gepolstert (Stoff, Leder, Stoff Celia nur für Frame Friendly) oder Eiche (fineer, nur möglich bei Frame, nicht bei Frame II)
Untergestell: Matchchrom, Epoxy fine texture auf Stahl (Frame Friendly nur in Schwarz)

4 **Finishes**

All Arco colors and finishes for the mentioned materials
Frame Friendly only in fabric Celia

Afwerkingen

Alle Arco kleuren en lakafwerkingen voor de genoemde materialen
Frame Friendly alleen in stof Celia

Ausführungen

Alle Arco Farben und Ausführungen für die genannten Materialien
Frame Friendly nur aus Stoff Celia

5 **Additional information**

The Frame Friendly has the same dimensions as the Frame/Frame XL

Aanvullende informatie

De Frame Friendly heeft dezelfde afmetingen als de Frame/Frame XL

Weitere Informationen

Der Frame Friendly hat die gleichen Abmessungen wie der Frame/Frame XL

product

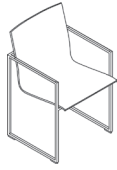
1 **Frame**2 **Standard**

Frame

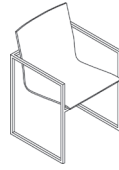

Frame XL

version	frame	oak		fabric					COM	leather				transport information			
		oak	fabric group basic	fabric group 1	fabric group 2	fabric group 3	fabric group 4	fabric group 5		fabric Celia	leather group a	leather group b	leather group c	leather group d	colli	m3	kg
Frame	epoxy	€ 654	€ 763	€ 799	€ 847	€ 872	€ 908	€ 975	€ 799		€ 956	€ 1011	€ 1156	€ 1204	1	0.25	8
Frame	mat chrome	€ 708	€ 829	€ 860	€ 902	€ 938	€ 968	€ 1029	€ 860		€ 1011	€ 1065	€ 1204	€ 1271	1	0.25	8
Frame XL	epoxy		€ 835	€ 872	€ 932	€ 956	€ 981	€ 1059	€ 872		€ 1017	€ 1096	€ 1235	€ 1338	1	0.32	9
Frame XL	mat chrome		€ 884	€ 944	€ 981	€ 1011	€ 1047	€ 1114	€ 944		€ 1071	€ 1162	€ 1295	€ 1404	1	0.32	9
Frame Friendly	epoxy 2									€ 648					1	0.25	8
Frame XL Friendly	epoxy 2									€ 702					1	0.32	9

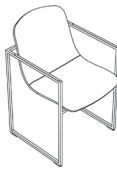

Frame II

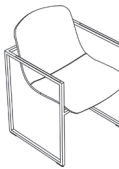

Frame II XL

version	frame	fabric							COM	leather				transport information		
		fabric group basic	fabric group 1	fabric group 2	fabric group 3	fabric group 4	fabric group 5	leather group a		leather group b	leather group c	leather group d	colli	m3	kg	
Frame II	epoxy	€ 654	€ 684	€ 726	€ 751	€ 805	€ 854	€ 684	€ 817	€ 890	€ 975	€ 1017	1	0.25	8	
Frame II	mat chrome	€ 684	€ 690	€ 726	€ 763	€ 835	€ 878	€ 690	€ 841	€ 908	€ 1011	€ 1047	1	0.25	8	
Frame II XL	epoxy	€ 672	€ 696	€ 733	€ 763	€ 817	€ 872	€ 696	€ 860	€ 932	€ 1041	€ 1096	1	0.32	9	
Frame II XL	mat chrome	€ 708	€ 720	€ 769	€ 811	€ 866	€ 908	€ 720	€ 890	€ 975	€ 1083	€ 1132	1	0.32	9	

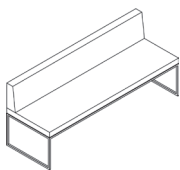

Frame bench

version	dimensions / frame	fabric							COM	leather				transport information		
		fabric group basic	fabric group 1	fabric group 2	fabric group 3	fabric group 4	fabric group 5	leather group a		leather group b	leather group c	leather group d	colli	m3	kg	
Frame bench	150x60x76cm epoxy	€ 2324	€ 2626	€ 2808	€ 2965	€ 3267	€ 3443	€ 2626	€ 3056	€ 3280	€ 3703	€ 3927	1	0.68	18	
Frame bench	150x60x76cm mat chrome	€ 2541	€ 2850	€ 3025	€ 3195	€ 3485	€ 3673	€ 2850	€ 3280	€ 3509	€ 3921	€ 4157	1	0.68	18	
Frame bench	180x60x76cm epoxy	€ 2505	€ 2711	€ 2874	€ 3050	€ 3346	€ 3528	€ 2711	€ 3243	€ 3509	€ 3951	€ 4266	1	0.82	21	
Frame bench	180x60x76cm mat chrome	€ 2723	€ 2923	€ 3092	€ 3267	€ 3564	€ 3739	€ 2923	€ 3461	€ 3727	€ 4175	€ 4490	1	0.82	21	
Frame bench	210x60x76cm epoxy	€ 2687	€ 2814	€ 3001	€ 3177	€ 3485	€ 3673	€ 2814	€ 3443	€ 3745	€ 4266	€ 4623	1	0.96	24	
Frame bench	210x60x76cm mat chrome	€ 2886	€ 3038	€ 3219	€ 3395	€ 3703	€ 3885	€ 3038	€ 3673	€ 3969	€ 4490	€ 4840	1	0.96	24	
Frame bench	240x60x76cm epoxy	€ 2771	€ 2923	€ 3104	€ 3286	€ 3618	€ 3818	€ 2923	€ 3649	€ 4000	€ 4562	€ 4961	1	1.09	27	
Frame bench	240x60x76cm mat chrome	€ 3001	€ 3128	€ 3328	€ 3516	€ 3842	€ 4030	€ 3128	€ 3866	€ 4217	€ 4786	€ 5191	1	1.09	27	

product

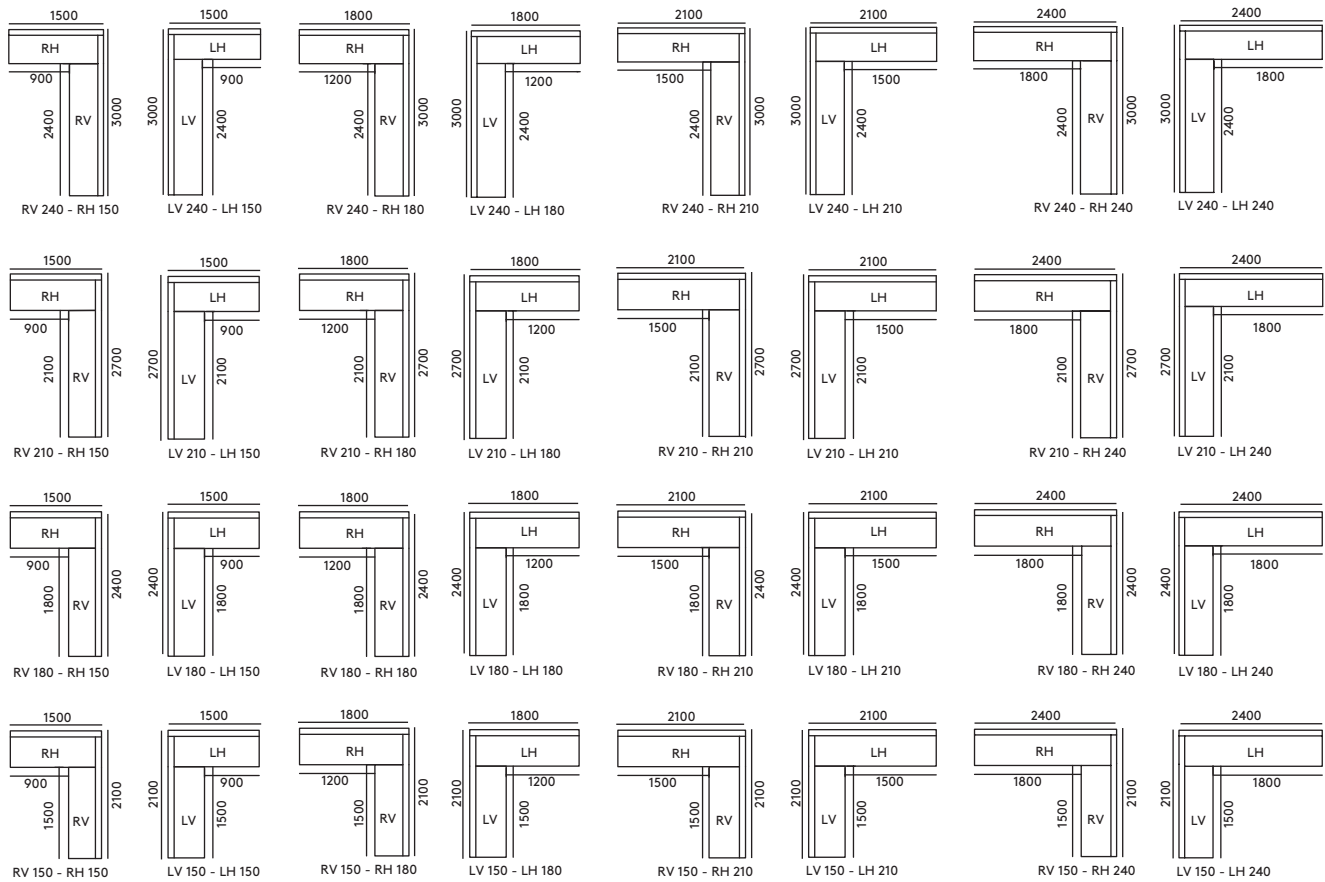
1 **Frame**2 **Standard****corner units right variant**

RV240-RH150 1 x bench 240cm + 1 x bench 150cm + € 310
 RV240-RH180 1 x bench 240cm + 1 x bench 180cm + € 310
 RV240-RH210 1 x bench 240cm + 1 x bench 210cm + € 310
 RV240-RH240 1 x bench 240cm + 1 x bench 240cm + € 310

RV210-RH150 1 x bench 210cm + 1 x bench 150cm + € 310
 RV210-RH180 1 x bench 210cm + 1 x bench 180cm + € 310
 RV210-RH210 1 x bench 210cm + 1 x bench 210cm + € 310
 RV210-RH240 1 x bench 210cm + 1 x bench 240cm + € 310

RV180-RH150 1 x bench 180cm + 1 x bench 150cm + € 310
 RV180-RH180 1 x bench 180cm + 1 x bench 180cm + € 310
 RV180-RH210 1 x bench 180cm + 1 x bench 210cm + € 310
 RV180-RH240 1 x bench 180cm + 1 x bench 240cm + € 310

RV150-RH150 1 x bench 150cm + 1 x bench 150cm + € 310
 RV150-RH180 1 x bench 150cm + 1 x bench 180cm + € 310
 RV150-RH210 1 x bench 150cm + 1 x bench 210cm + € 310
 RV150-RH240 1 x bench 150cm + 1 x bench 240cm + € 310

corner units left variant

LV240-LH240 1 x bench 240cm + 1 x bench 240cm + € 310
 LV240-LH210 1 x bench 240cm + 1 x bench 210cm + € 310
 LV240-LH180 1 x bench 240cm + 1 x bench 180cm + € 310
 LV240-LH150 1 x bench 240cm + 1 x bench 150cm + € 310

LV210-LH240 1 x bench 210cm + 1 x bench 240cm + € 310
 LV210-LH210 1 x bench 210cm + 1 x bench 210cm + € 310
 LV210-LH180 1 x bench 210cm + 1 x bench 180cm + € 310
 LV210-LH150 1 x bench 210cm + 1 x bench 150cm + € 310

LV180-LH240 1 x bench 180cm + 1 x bench 240cm + € 310
 LV180-LH210 1 x bench 180cm + 1 x bench 210cm + € 310
 LV180-LH180 1 x bench 180cm + 1 x bench 180cm + € 310
 LV180-LH150 1 x bench 180cm + 1 x bench 150cm + € 310

LV150-LH240 1 x bench 150cm + 1 x bench 240cm + € 310
 LV150-LH210 1 x bench 150cm + 1 x bench 210cm + € 310
 LV150-LH180 1 x bench 150cm + 1 x bench 180cm + € 310
 LV150-LH150 1 x bench 150cm + 1 x bench 150cm + € 310

product

1 Frame

3 Materials

For a current list of all possible fabrics and their classification in fabric groups, consult the list of fabrics and leathers on our website www.arco.nl.

4 Finishes

For an overview of all current Arco colors, please refer to this price list page 5 ff or visit our website www.arco.nl.

5 Additional information

Duo upholstery possible for Frame II/II XL (inside and outside seat): price entirely in the most expensive fabric/leather + surcharge € 50 per chair (gross incl. VAT).

Frame

COM: 1,5 gross of plain fabric, minimum width 130 cm for 2 chairs (minimum order quantity).

Frame XL

COM: 1,6 gross of plain fabric, minimum width 130 cm for 2 chairs (minimum order quantity).

Frame II

COM: 1,55 gross of plain fabric, minimum width 130 cm for 2 chairs (minimum order quantity).

Frame II XL

COM: 1,65 gross of plain fabric, minimum width 130 cm for 2 chairs (minimum order quantity).

Frame Bench

COM: 2,7/3,6/3,7/4,5 gross of plain fabric, minimum width 130 cm per bench. Corner formations: on request.

Ordering support

	example
type	Frame II XL
material seat	Hallingdal 65
color seat	116
material frame	Epoxy Fine Texture
color frame	5301 - RAL 9005 black
finish frame	n.a.

product

designer

year

1 Home-Work

Jonathan Prestwich

2023

2 Standard

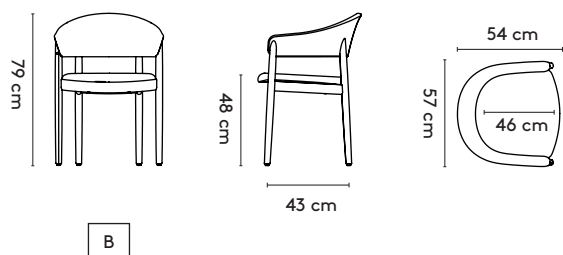

3 Materials

Seat and back: fabric
Frame: oak (solid)

Materialen

Zitting en rugleuning: stof
Onderstel: eiken (massief)

Materialien

Sitz und Rücken: Stoff
Untergestell: Eiche (Massiv)

4 Finishes

All Arco colors and only N- or P-lacquer finishes for the mentioned materials

Afwerkingen

Alle Arco kleuren en alleen N- of P-lak voor de genoemde materialen

Ausführungen

Alle Arco Farben und nur N- oder P-lack Ausführungen für die genannte Materialien

5 Additional information

The Home-Work's cover can be replaced at the end of its lifespan. For this reason the upholstery requires more consistency to ensure that the cover fits with absolute precision. As a result we're only able to offer a limited number of fabrics. See point 3 on the price page.

Aanvullende informatie

De bekleding van de Home-Work kan aan het einde van de levensduur worden vervangen. Daarom vereist deze meer stevigheid, om ervoor te zorgen dat de hoes precies past. Als gevolg daarvan is een beperkt aantal stoffen mogelijk. Zie punt 3 op de prijspagina.

Weitere Informationen

Der Bezug von des Home-Work kann am Ende seiner Lebensdauer erneut werden. Damit der Bezug passgenau sitzt, muss die Polsterung eine stabilere Konsistenz haben, und es kommt nur eine begrenzte Anzahl von Stoffen in Frage. Weitere Informationen siehe Punkt 3 auf der Preisseite.

product

1 Home-Work

2 Standard



Home-Work B

version	dimensions	fabric					transport information		
		fabric group basic	fabric group 2	fabric group 3	fabric group 4	fabric group 5	colli	m ³	kg
Home-Work B	Home-Work B	€ 950	€ 1053	€ 1102	€ 1162	€ 1253	1	0.38	7

3 Materials

The Home-Work's cover can be replaced at the end of its lifespan. For this reason the upholstery requires more consistency to ensure that the cover fits with absolute precision. As a result we're only able to offer a limited number of fabrics:

fabric group basic: Main Line Flax;

fabric group 2: Steelcut Trio;

fabric group 3: Re-wool, Monza, Monza melange, Moss (Kvadrat);

fabric group 4: Savanna, Divina Melange, Divina MD, Hallingdal 65, Mizmaze, Vanir, Arda, Sisu, Ploegwool;

fabric group 5: Apparel, Planum, Twinwool.

4 Finishes

For an overview of all current Arco colors, please refer to this price list page 5 ff or visit our website www.arco.nl.

5 Additional information

COM is available on request for orders of fifty chairs or more. The Home-Work is not available in leather for the time being.

Ordering support

type
material back
color back
material seat
color seat
material frame
color frame
finish frame

example

Home-Work B
Main Line Flax
15
Main Line Flax
15
oak
1300 - black
N-lacquer

product

designer

year

1 **Laze**

**Gudmundur
Ludvik**

2019 - 2022

2 **Standard**

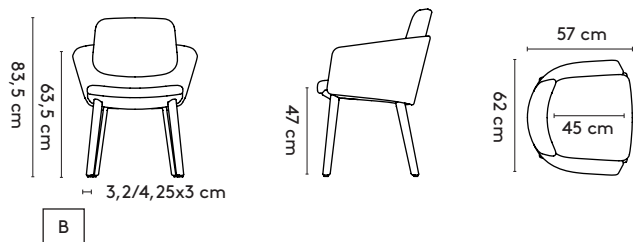

3 **Materials**

Seat: fabric or leather
Cushions: fabric or leather
Frame:
B. oak (solid)

Materialen

Kuip: stof of leder
Kussens: stof of leder
Onderstel:
B. eiken (massief)

Materialien

Sitz: Stoff oder Leder
Kissen: Stoff oder Leder
Untergestell:
B. Eiche (Massiv)

4 **Finishes**

All Arco colors and only N- or P-lacquer finishes for the mentioned materials

Afwerkingen

Alle Arco kleuren en alleen N- of P-lak voor de genoemde materialen

Ausführungen

Alle Arco Farben und nur N- oder P-lack Ausführungen für die genannte Materialien

5 **Additional information**

-

Aanvullende informatie

-

Weitere Informationen

-

product

1 **Laze**2 **Standard**

Laze

version	frame	fabric							leather				transport information		
		fabric group basic	fabric group 1	fabric group 2	fabric group 3	fabric group 4	fabric group 5	COM	leather group a	leather group b	leather group c	leather group d	colli	m3	kg
Laze	oak	€ 1029	€ 1083	€ 1180	€ 1217	€ 1313	€ 1567	€ 1083	€ 1313	€ 1440	€ 1694	€ 1815	1	0.60	11

3 **Materials**

For a current list of all possible fabrics and their classification in fabric groups, consult the list of fabrics and leathers on our website www.arco.nl.

4 **Finishes**

For an overview of all current Arco colors, please refer to this price list page 5 ff or visit our website www.arco.nl.

5 **Additional information**

Duo upholstery possible (cushions/seat other fabric/leather): price entirely in the most expensive fabric/leather + surcharge € 50 per chair (gross incl. VAT).

COM total: 1,9 gross of plain fabric, minimum width 130 cm per chair.

COM cushion: 1,1 gross of plain fabric, minimum width 130 cm per chair.

COM seat: 1,35 gross of plain fabric, minimum width 130 cm per chair.

Ordering support

type
material seat
color seat
material cushion
material frame
color frame
finish frame

example

Laze
Colline 2
177
leather d.SK
oak
1300 - black
N-lacquer

product

designer

year

1 Re-volve

Gudmundur Ludvik

2022

2 Standard

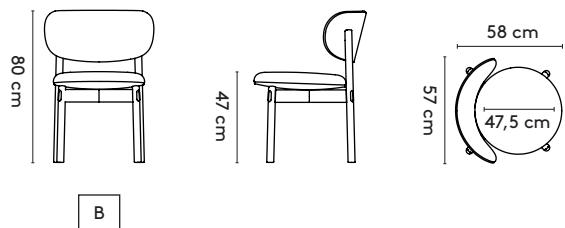

3 Materials

Seat and inside of back: fabric or leather
Frame: oak (solid)
Back (outside): oak (veneer)

Materialen

Zitting en binnenzijde rugleuning: stof of leder
 Onderstel: eiken (massief)
 Rug (buitenzijde): eiken (fineer)

Materialien

Sitz und Innenseite Rücken: Stoff oder Leder
 Untergestell: Eiche (Massiv)
 Rücken (Außenseite): Eiche (Furnier)

4 Finishes

All Arco colors and only N- or P-lacquer finishes for the mentioned materials

Afwerkingen

Alle Arco kleuren en alleen N- of P-lak voor de genoemde materialen

Ausführungen

Alle Arco Farben und nur N- oder P-lack Ausführungen für die genannte Materialien

5 Additional information

-

Aanvullende informatie

-

Weitere Informationen

-

product

1 **Re-volve**

Re-volve

version	frame	fabric							leather				transport information		
		fabric group basic	fabric group 1	fabric group 2	fabric group 3	fabric group 4	fabric group 5	COM	leather group a	leather group b	leather group c	leather group d	colli	m3	kg
Re-volve	oak	€ 932	€ 1017	€ 1047	€ 1126	€ 1241	€ 1356	€ 1017	€ 1126	€ 1350	€ 1501	€ 1610	1	0.60	11

3 **Materials**

For a current list of all possible fabrics and their classification in fabric groups, consult the list of fabrics and leathers on our website www.arco.nl.

4 **Finishes**

For an overview of all current Arco colors, please refer to this price list page 5 ff or visit our website www.arco.nl.

5 **Additional information**

Duo upholstery possible (seat other fabric/leather): price entirely in the most expensive fabric/leather + surcharge € 50 per chair (gross incl. VAT).

COM total: 0,7 gross of plain fabric, minimum width 130 cm per chair.

COM back: 0,5 gross of plain fabric, minimum width 130 cm per chair.

COM seat: 0,7 gross of plain fabric, minimum width 130 cm per chair.

Ordering support

type
material seat/back inside
color seat/back inside
material frame/back outside
color frame/back outside
finish frame/back outside

example

Re-volve
Sisu
0165
oak
1301 - carbon
N-lacquer

product

designer

year

1 Side by Side

Dick Spienburg & Karel Boonzaaijer

2008

2 Standard

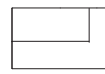
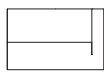
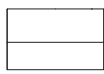
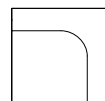
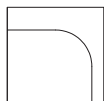
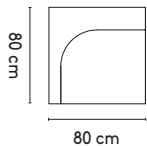

Element low 1
80 x 80 x 51 cm

Element low 2
80 x 80 x 51 cm

Element low 3
80 x 80 x 51 cm

Element low 4
80 x 80 x 51 cm

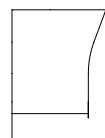
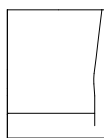
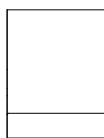
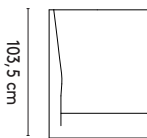

Element high 1
80 x 80 x 103,5 cm

Element high 2
80 x 80 x 103,5 cm

Element high 3
80 x 80 x 103,5 cm

Element high 4
80 x 80 x 103,5 cm



Frame
80 x 80 x 16,5 cm
160 x 80 x 16,5 cm
240 x 80 x 16,5 cm

3 Materials

Elements: upholstered (fabric)
Frame: epoxy fine texture on steel RAL9005

Materialen

Elementen: gestoffeerd (stof)
Onderstel: epoxy fine texture op staal RAL9005

Materialien

Elementen: gepolstert (Stoff)
Untergestell: Epoxy Fine Texture auf Stahl RAL9005

4 Finishes

All Arco colors and finishes for the mentioned materials

Afwerkingen

Alle Arco kleuren en afwerkingen voor de genoemde materialen

Ausführungen

Alle Arco Farben und Ausführungen für die genannten Materialien

5 Additional information

Side by Side has its own fabric group. See point 3 on the price page

Aanvullende informatie

Voor de Side by Side geldt een eigen stofgroep indeling. Zie hiervoor punt 3 op de prijspagina

Weitere Informationen

Side by Side hat eine eigene Stoffgruppe. Siehe Punkt 3 auf der Preisseite

product

1 Side by Side

2 Standard

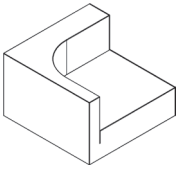

Element low 1

version	fabric						transport information		
	fabric group a	fabric group b	fabric group c	fabric group d	fabric group e	fabric group f	colli	m3	kg
Element low 1	€ 1840	€ 1894	€ 2039	€ 2130	€ 2185	€ 2251	1	0.43	25

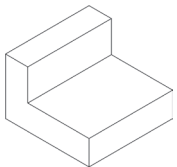

Element low 2

version	fabric						transport information		
	fabric group a	fabric group b	fabric group c	fabric group d	fabric group e	fabric group f	colli	m3	kg
Element low 2	€ 1567	€ 1628	€ 1707	€ 1755	€ 1828	€ 1894	1	0.43	25

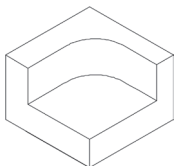

Element low 3

version	fabric						transport information		
	fabric group a	fabric group b	fabric group c	fabric group d	fabric group e	fabric group f	colli	m3	kg
Element low 3	€ 1840	€ 1894	€ 2039	€ 2130	€ 2185	€ 2251	1	0.43	25

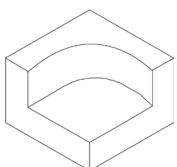

Element low 4

version	fabric						transport information		
	fabric group a	fabric group b	fabric group c	fabric group d	fabric group e	fabric group f	colli	m3	kg
Element low 4	€ 2003	€ 2064	€ 2209	€ 2299	€ 2348	€ 2408	1	0.43	25

product

1 Side by Side

2 Standard

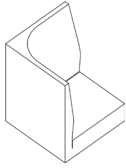

Element high 1

version	fabric						transport information		
	fabric group a	fabric group b	fabric group c	fabric group d	fabric group e	fabric group f	colli	m3	kg
Element high 1	€ 2312	€ 2499	€ 2687	€ 2820	€ 2959	€ 3025	1	0.66	35

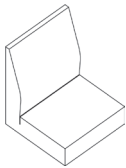

Element high 2

version	fabric						transport information		
	fabric group a	fabric group b	fabric group c	fabric group d	fabric group e	fabric group f	colli	m3	kg
Element high 2	€ 1936	€ 2088	€ 2251	€ 2360	€ 2475	€ 2529	1	0.66	35

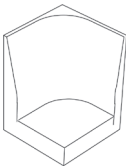

Element high 3

version	fabric						transport information		
	fabric group a	fabric group b	fabric group c	fabric group d	fabric group e	fabric group f	colli	m3	kg
Element high 3	€ 2312	€ 2499	€ 2687	€ 2820	€ 2959	€ 3025	1	0.66	35

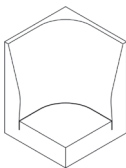

Element high 4

version	fabric						transport information		
	fabric group a	fabric group b	fabric group c	fabric group d	fabric group e	fabric group f	colli	m3	kg
Element high 4	€ 2439	€ 2626	€ 2832	€ 2965	€ 3080	€ 3159	1	0.66	35

product

1 Side by Side

2 Standard

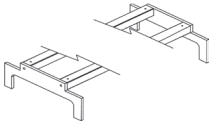

Frame 1

version	dimensions	Steel	transport information		
		epoxy FT RAL9005	colli	m3	kg
Frame 1	80x16cm	€ 575	0	0.00	0
Frame 1	160x16cm	€ 666	0	0.00	0
Frame 1	240x16cm	€ 775	0	0.00	0

3 Materials

The Side by Side is available in:

fabricgroup A: Fabrixx Wool;
 fabricgroup b: Blazer, Europost;
 fabricgroup c: Fiord, Clara, Remix, Canvas;
 fabricgroup d: Hallingdal, Ploegwool, Tonica, Tonus, Rewool, Steelcut trio, Divina melange;
 fabricgroup e: Sunniva, Steelcut;
 fabricgroup f: Divina, Divina MD.

Other fabrics on request only.

4 Finishes

For an overview of all current Arco colors, please refer to this price list page 5 ff or visit our website www.arco.nl.

5 Additional information

-

Ordering support

	example
type	formation
material elements	Hallingdal 65
color elements	126
color frame	epoxy fine texture RAL9005
finish frame	n.a.

When ordering, please always submit a drawing. Separate elements add up!

product

designer

year

1 Sketch Office

Burkhard Vogtherr & Jonathan Prestwich

2014 - 2018

2 Standard

Sketch work low

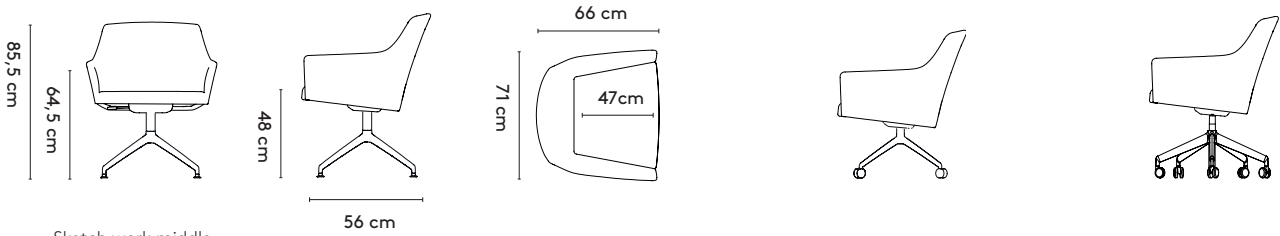

Sketch work middle

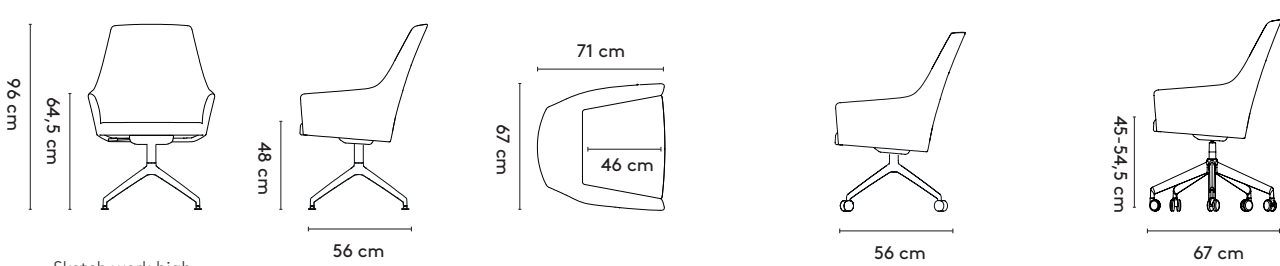

Sketch work high

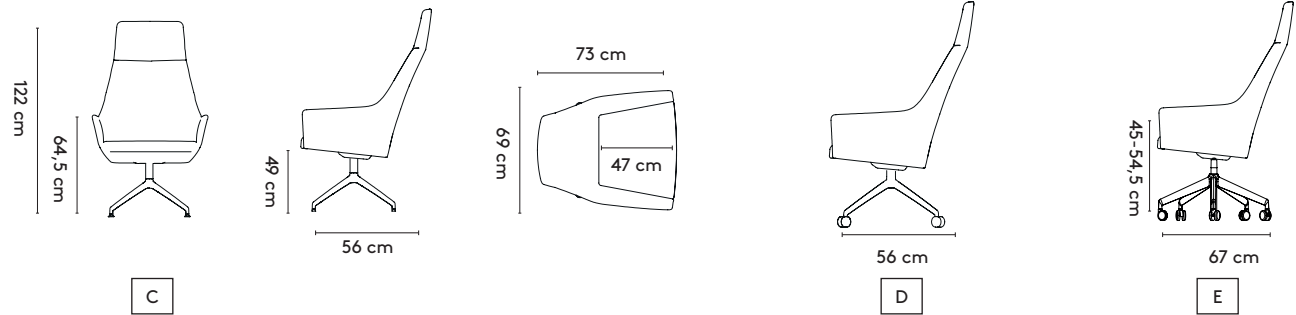

C

D

E

Sketch lobby

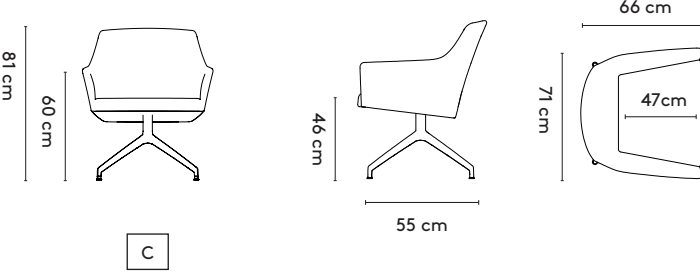

C

Sketch lounge

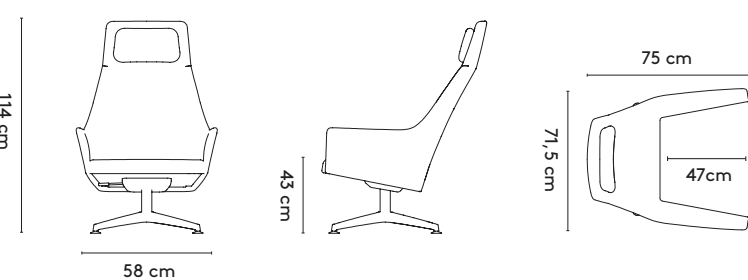

G

Sketch hocker

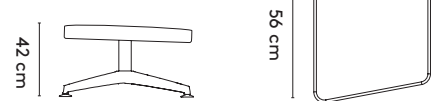

product

designer

year

1 Sketch Office

Burkhard Vogtherr & Jonathan Prestwich

2014 - 2018

3

Materials

Sketch low/middle/high

Seat: upholstered (fabric, leather)

Frame:

C. 4 feet central base (swivel) on feet: polished aluminium, epoxy fine texture on aluminium

D. 4 feet central base (fixed) on castors: polished aluminum, epoxy fine texture on aluminum

E. 5 feet central base (swivel, height adjustable + tilt) on castors: polished aluminum, epoxy fine texture on aluminum

G. 4 feet central base (swivel and tilting): polished aluminum, epoxy fine texture on aluminum

Materialen

Sketch low/middle/high

Kuip: gestoffeerd (stof, leder)

Onderstel:

C. 4 teens centrale voet (draaibaar) op pootjes: gepolijst aluminium, epoxy fine texture op aluminium

D. 4 teens centrale voet (vast) op wielen: gepolijst aluminium, epoxy fine texture op aluminium

E. 5 teens centrale voet (draaibaar, met gasveer + tilt) op wielen : epoxy fine texture op aluminium

G. 4 teens centrale voet (draaibaar met tiltmechanisme): gepolijst aluminium, epoxy fine texture op aluminium

Materialien

Sketch low/middle/high

Sitzschale: gepolstert (Stoff, Leder)

Untergestell:

C. 4 Bein Zentralfuss (drehbar) auf Füsse: poliertes Aluminium, Epoxylack auf Aluminium, Epoxy fine texture auf Aluminium

D. 4 Bein Zentralfuss (fest) auf Rollen: poliertes Aluminium, Epoxy fine texture auf Aluminium

E. 5 Bein Zentralfuss (drehbar, mit Gasfeder + tilt) auf Rollen : poliertes Aluminium, Epoxy fine texture auf Aluminium

G. 4 Bein Zentralfuss (drehbar und Neigung): poliertes Aluminium, Epoxy fine texture auf Aluminium

4

Finishes

All Arco colors and finishes for the mentioned materials

Afwerkingen

Alle Arco kleuren en lakafwerkingen voor de genoemde materialen

Ausführungen

Alle Arco Farben und Ausführungen für die genannten Materialien

5

Additional information

Inside and outside seat in different fabric optional

Aanvullende informatie

Binnen- en buitenzijde kuip in andere stof mogelijk

Weitere Informationen

Innen- und Aussenseite Sitzschale in einem anderen Stoff möglich

product

1 Sketch Office

2 Standard



Sketch Work low C



Sketch Work low D



Sketch Work low E

version	frame	fabric							COM	leather				transport information		
		fabric group basic	fabric group 1	fabric group 2	fabric group 3	fabric group 4	fabric group 5	leather group a		leather group b	leather group c	leather group d	colli	m3	kg	
Sketch Work low C	alu/epoxy swivel	€ 1168	€ 1217	€ 1331	€ 1350	€ 1573	€ 1688	€ 1217	€ 1465	€ 1616	€ 1906	€ 1973	1	0.35	9	
Sketch Work low D	alu/epoxy fixed	€ 1168	€ 1217	€ 1331	€ 1350	€ 1573	€ 1688	€ 1217	€ 1465	€ 1616	€ 1906	€ 1973	1	0.35	9	
Sketch Work low E	alu/epoxy swivel h-adjustable	€ 1247	€ 1295	€ 1404	€ 1434	€ 1658	€ 1767	€ 1295	€ 1543	€ 1688	€ 1991	€ 2039	1	0.35	9	



Sketch Work middle C



Sketch Work middle D



Sketch Work middle E

version	frame	fabric							COM	leather				transport information		
		fabric group basic	fabric group 1	fabric group 2	fabric group 3	fabric group 4	fabric group 5	leather group a		leather group b	leather group c	leather group d	colli	m3	kg	
Sketch Work middle C	alu/epoxy swivel	€ 1307	€ 1368	€ 1471	€ 1531	€ 1682	€ 1803	€ 1368	€ 1622	€ 1779	€ 1973	€ 2088	1	0.35	14	
Sketch Work middle D	alu/epoxy fixed	€ 1307	€ 1368	€ 1471	€ 1531	€ 1682	€ 1803	€ 1368	€ 1622	€ 1779	€ 1973	€ 2088	1	0.35	14	
Sketch Work middle E	alu/epoxy swivel h-adjustable	€ 1386	€ 1452	€ 1543	€ 1604	€ 1761	€ 1882	€ 1452	€ 1688	€ 1858	€ 2057	€ 2166	1	0.35	14	



Sketch Work high C



Sketch Work high D



Sketch Work high E

version	frame	fabric							COM	leather				transport information		
		fabric group basic	fabric group 1	fabric group 2	fabric group 3	fabric group 4	fabric group 5	leather group a		leather group b	leather group c	leather group d	colli	m3	kg	
Sketch Work high C	alu/epoxy swivel	€ 1682	€ 1828	€ 1955	€ 2009	€ 2233	€ 2378	€ 1828	€ 2172	€ 2336	€ 2566	€ 2662	1	0.50	20	
Sketch Work high D	alu/epoxy fixed	€ 1682	€ 1828	€ 1955	€ 2009	€ 2233	€ 2378	€ 1828	€ 2172	€ 2336	€ 2566	€ 2662	1	0.50	20	
Sketch Work high E	alu/epoxy swivel h-adjustable	€ 1761	€ 1912	€ 2033	€ 2088	€ 2318	€ 2463	€ 1912	€ 2251	€ 2414	€ 2644	€ 2747	1	0.50	20	

product

1 Sketch Office

2 Standard



Sketch lobby C

version	frame	fabric							leather				transport information		
		fabric group basic	fabric group 1	fabric group 2	fabric group 3	fabric group 4	fabric group 5	COM	leather group a	leather group b	leather group c	leather group d	colli	m3	kg
Sketch lobby C	alu/epoxy	€ 1168	€ 1217	€ 1331	€ 1350	€ 1573	€ 1688	€ 1217	€ 1465	€ 1616	€ 1906	€ 1973	1	0.35	9



Sketch lounge G

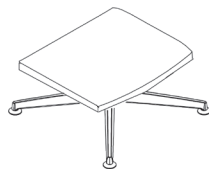

Sketch Lounge Hocker

version	frame	fabric							leather				transport information		
		fabric group basic	fabric group 1	fabric group 2	fabric group 3	fabric group 4	fabric group 5	COM	leather group a	leather group b	leather group c	leather group d	colli	m3	kg
Sketch lounge G	alu/epoxy	€ 1943	€ 2057	€ 2203	€ 2293	€ 2511	€ 2687	€ 2057	€ 2414	€ 2638	€ 2911	€ 3050	1	0.50	18
Sketch Lounge Hocker	alu/epoxy	€ 527	€ 539	€ 581	€ 618	€ 678	€ 726	€ 539	€ 618	€ 678	€ 739	€ 793	1	0.14	7

3 Materials

For a current list of all possible fabrics and their classification in fabric groups, consult the list of fabrics and leathers on our website www.arco.nl.

4 Finishes

For an overview of all current Arco colors, please refer to this price list page 5 ff or visit our website www.arco.nl.

5 Additional information

Duo upholstery possible (inside and outside seat): price entirely in the most expensive fabric/leather + surcharge € 50 per chair (gross incl. VAT).

Sketch Work Low

COM: 1,95 gross of plain fabric, minimum width 130 cm per chair.

Sketch Work Middle

COM: 2,3 gross of plain fabric, minimum width 130 cm per chair.

Sketch Work High

COM: 2,6 gross of plain fabric, minimum width 130 cm per chair.

product

1 Sketch Office

Sketch Lobby

COM: 1,95 gross of plain fabric, minimum width 130 cm per chair.

Sketch Lounge

COM: 2,6 gross of plain fabric, minimum width 130 cm per chair.

Sketch Lounge Hocker

COM: 0,9 gross of plain fabric, minimum width 130 cm per chair.

Ordering support

type
material seat
color seat
material frame
color frame

example

Sketch lobby C
Divina MD
173
epoxy fine texture
5301 - RAL 9005 black

1 Sketch regular

Burkhard Vogtherr & Jonathan Prestwich

2010

2 Standard

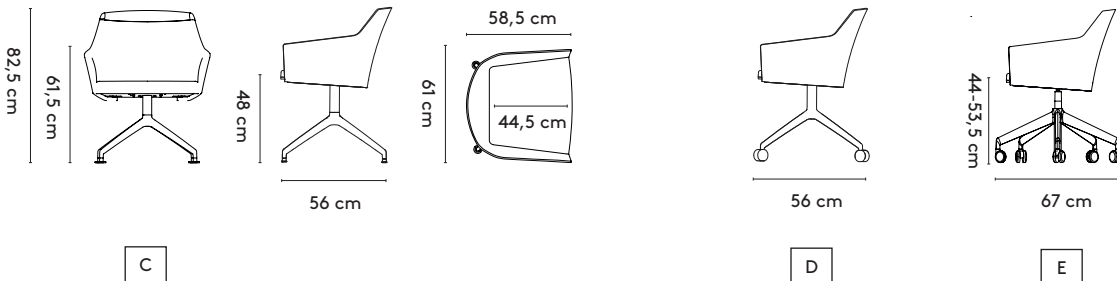

3 Materials

Seat: upholstered (fabric, leather)

Frame:

C. 4 feet central base (swivel, swivel with auto-return) on feet: polished aluminum, epoxy fine texture on aluminum

D. 4 feet central base (fixed) on castors: polished aluminum, epoxy fine texture on aluminum

E. 5 feet central base (swivel, height adjustable) on castors: polished aluminum, epoxy fine texture on aluminum

Materialen

Kuip: gestoffeerd (stof, leder)

Onderstel:

C. 4 teens centrale voet (draaibaar, draaibaar met auto return) op pootjes: gepolijst aluminium, epoxy fine texture op aluminium

D. 4 teens centrale voet (vast) op wielen: gepolijst aluminium, epoxy fine texture op aluminium

E. 5 teens centrale voet (draaibaar met gasveer) op wielen: gepolijst aluminium, epoxy fine texture op aluminium

Materialien

Sitzschale: gepolstert (Stoff, Leder)

Untergestell:

C. 4 Bein Zentralfuss (drehbar, drehbar mit Auto-return) auf Füsse: poliertes Aluminium, Epoxy fine texture auf Aluminium

D. 4 Bein Zentralfuss (fest) auf Rollen: poliertes Aluminium, Epoxy fine texture auf Aluminium

E. 5 Bein Zentralfuss (drehbar mit Gasfeder) auf Rollen: poliertes Aluminium, Epoxy fine texture auf Aluminium

4 Finishes

All Arco colors and finishes for the mentioned materials

Afwerkingen

Alle Arco kleuren en lakafwerkingen voor de genoemde materialen

Ausführungen

Alle Arco Farben und Ausführungen für die genannten Materialien

5 Additional information

Inside and outside seat in different fabrics optional

Aanvullende informatie

Binnen- en buitenzijde kuip in andere stof mogelijk

Weitere Informationen

Innen- und Aussenseite Sitzschale in einem anderen Stoff möglich

product

1 Sketch regular

2 Standard



Sketch regular C



Sketch regular D



Sketch regular E

version	frame	fabric							leather				transport information		
		fabric group basic	fabric group 1	fabric group 2	fabric group 3	fabric group 4	fabric group 5	COM	leather group a	leather group b	leather group c	leather group d	colli	m3	kg
Sketch regular C	alu/epoxy swivel	€ 1065	€ 1138	€ 1198	€ 1259	€ 1471	€ 1567	€ 1138	€ 1489	€ 1573	€ 1761	€ 1888	1	0.33	9
Sketch regular C	alu/epoxy autoreturn	€ 1156	€ 1223	€ 1283	€ 1356	€ 1567	€ 1646	€ 1223	€ 1573	€ 1664	€ 1858	€ 1973	1	0.33	9
Sketch regular D	alu/epoxy fixed	€ 1065	€ 1138	€ 1198	€ 1259	€ 1471	€ 1567	€ 1138	€ 1489	€ 1573	€ 1761	€ 1888	1	0.33	9
Sketch regular E	alu/epoxy swivel h-adjustable	€ 1150	€ 1217	€ 1277	€ 1350	€ 1561	€ 1640	€ 1217	€ 1573	€ 1658	€ 1852	€ 1967	1	0.33	9

3 Materials

For a current list of all possible fabrics and their classification in fabric groups, consult the list of fabrics and leathers on our website www.arco.nl.

4 Finishes

For an overview of all current Arco colors, please refer to this price list page 5 ff or visit our website www.arco.nl.

5 Additional information

Duo upholstery possible (inside and outside seat): price entirely in the most expensive fabric/leather + surcharge € 50 per chair (gross incl. VAT).

COM: 3,5 gross of plain fabric, minimum width 130 cm for 2 chairs (minimum order quantity 2).

Ordering support

type
material seat
color seat
material frame
color frame
finish frame

example

Sketch regular C
Comfort
122
epoxy fine texture
5301 - RAL 9005 black
n.a.

Low tables & Flexible objects

p. 168 **Bow**
p. 170 **Dew Cofee Table**
p. 172 **Pivot**
p. 174 **Tablet**
p. 176 **Tre**
p. 178 **Utensil**

we complement homes

product

designer

year

1 **Bow**

**Uli Budde &
Ivan Kasner**

2020

2 **Standard**

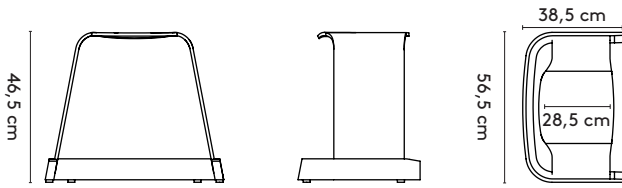

3 **Materials**

Base: oak (solid)
Seat: beech laminate with oak top layer

Materialen

Voet: eiken (massief)
Zitting: beuken laminaat met eiken toplaag

Materialien

Fuss: Eiche (Massiv)
**Sitz: Buche Laminate mit Eiche
Oberbeschichtung**

4 **Finishes**

**All Arco colors with N-finish for the men-
tioned materials**

Afwerkingen

**Alle Arco kleuren met N-lakvoor de genoemde
materialen**

Ausführungen

**Alle Arco Farben mit N-Lack für die genannten
Materialien**

5 **Additional information**

Stackable: 4 maximum

Aanvullende informatie

Stapelbaar: maximaal 4

Weitere Informationen

Stapelbar: 4 Maximum

product

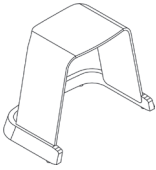
1 **Bow**2 **Standard**Bow

		oak	transport information		
version	dimensions	oak	colli	m3	kg
Bow	56x38x46 cm	€ 484	1	0.10	3

3 **Materials**

-

4 **Finishes**

For an overview of all current Arco colors, please refer to this price list page 5 ff or visit our website www.arco.nl.

5 **Additional information**

Stackable: 4 maximum

Ordering support

type
material stool
color stool
finish stool

example

Bow
oak
1401 - burgundy
N-lacquer

product

designer

year

1 Dew Coffee Table

Sabine Marcelis

2024

2 Standard

Dew Coffee Table

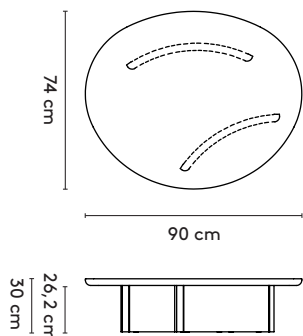

90 x 74 x 30 cm	140 x 75 x 30 cm
90 x 74 x 37,5 cm	140 x 75 x 37,5 cm
120 x 98 x 30 cm	160 x 85 x 30 cm
120 x 98 x 37,5 cm	160 x 85 x 37,5 cm

3 Materials

Top: oak or walnut (solid), oak smoked (solid)
Columns: oak or walnut (duramas), oak smoked (duramas)

Materialen

Blad: eiken of noten (massief), gerookt eiken (massief)
 Kolommen: eiken of noten (duramas), gerookt eiken (duramas)

Materialien

Platte: Eiche oder Nussbaum (Massiv), Eiche geräuchert (Massiv)
 Säule: Eiche oder Nussbaum (Duramas), Eiche geräuchert (Duramas)

4 Finishes

All Arco colors and finishes for the mentioned materials

Afwerkingen

Alle Arco kleuren en (lak)afwerkingen voor de genoemde materialen

Ausführungen

Alle Arco Farben und Ausführungen für die genannten Materialien

5 Additional information

-

Aanvullende informatie

-

Weitere Informationen

-

6 Cable management

-

product

1 Dew Coffee Table

2 Standard



Dew Coffee Table

version	dimensions	Oak	smoked oak	Walnut	transport information		
		solid	solid	solid	colli	m3	kg
Dew Coffee Table	90x74x30	€ 2160	€ 2378	€ 2874	3	0.05	21
Dew Coffee Table	90x74x37.5	€ 2160	€ 2378	€ 2874	3	0.05	22
Dew Coffee Table	120x98x30	€ 2687	€ 2977	€ 3770	3	0.07	32
Dew Coffee Table	120x98x37.5	€ 2687	€ 2977	€ 3770	3	0.07	33
Dew Coffee Table	140x75x30	€ 3104	€ 3310	€ 4629	3	0.07	30
Dew Coffee Table	140x75x37.5	€ 3104	€ 3310	€ 4629	3	0.07	32
Dew Coffee Table	160x85x30	€ 3443	€ 3667	€ 5331	3	0.08	38
Dew Coffee Table	160x85x37.5	€ 3443	€ 3667	€ 5331	3	0.08	39

3 Materials

-

4 Finishes

For an overview of all current Arco colors, please refer to this price list page 5 ff or visit our website www.arco.nl.

5 Additional information

-

Ordering support

type
size
material table
color table
finish table

example

Dew Coffee Table
120x98x30cm
oak solid
1400 - terra
N-lacquer

1 **Pivot****Raw Edges****2008**

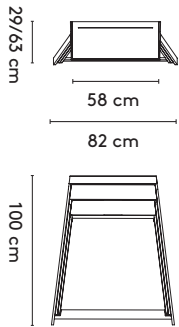
2 **Standard**3 **Materials**

Body: oak (solid)
Legs: oak (solid)

Materialen

Romp: eiken (massief)
 Poten: eiken (massief)

Materialien

Korpus: Eiche (Massiv)
 Füsse: Eiche (Massiv)

4 **Finishes**

All Arco colors and finishes for
 the mentioned materials

Afwerkingen

Alle Arco kleuren en (lak)afwerkingen voor
 de genoemde materialen

Ausführungen

Alle Arco Farben und Ausführungen für
 die genannten Materialien

5 **Additional information**

-

Aanvullende informatie

-

Weitere Informationen

-

product

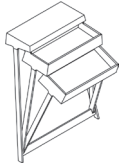
1 **Pivot**2 **Standard**

Pivot

		oak	transport information		
version	dimensions	solid	colli	m ³	kg
Pivot	82x29/63x100 cm	€ 2009	1	0.25	11

3 **Materials**

-

4 **Finishes**

For an overview of all current Arco colors, please refer to this price list page 5 ff or visit our website www.arco.nl.

5 **Additional information**

-

Ordering support

type
color
finish

example

Pivot
1200 - grey
P-lacquer

1 **Tablet****Jonas
Trampedach**

2014

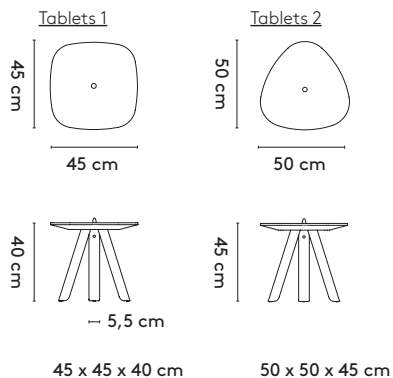
2 **Standard**3 **Materials**

Top: oak (veneer)
Legs: oak (solid)
Tab: leather (naturel, brown)

Materialen

Blad: eiken (fineer)
Onderstel: eiken (massief)
Lusje: leder (naturel, brown)

Materialien

Platte: Eiche (Furnier)
 Beine: Eiche (Massiv)
 Schlaufe: Leder (naturel, brown)

4 **Finishes**

All Arco colors and finishes for the mentioned materials

Afwerkingen

Alle Arco kleuren en (lak)afwerkingen voor de genoemde materialen

Ausführungen

Alle Arco Farben und Ausführungen für die genannten Materialien

5 **Additional information**

-

Aanvullende informatie

-

Weitere Informationen

-

product

1 Tablet

2 Standard



Tablet 1

Tablet 2

		oak	transport information		
version	dimensions	veneer	colli	m3	kg
Tablet 1	45x45x40cm	€ 484	1	0.05	4
Tablet 2	50x50x45cm	€ 497	1	0.03	5

3 Materials

-

4 Finishes

For an overview of all current Arco colors, please refer to this price list page 5 ff or visit our website www.arco.nl.

5 Additional information

-

Ordering support

type
size
material top
color top
finish top
material legs
color legs
finish legs

example

Tablet 2
50x50x45cm
oak veneer
1100 - natural
N-lacquer
oak solid
1100 - natural
N-lacquer

product

designer

year

1 **Tre**

**Jonas
Trampedach**

2010

2 **Standard**

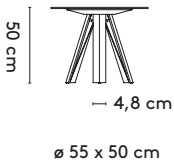
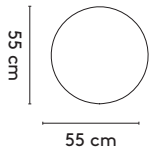

3 **Materials**

**Top: oak (solid)
Legs: oak (solid)**

Materialen

Blad: eiken (massief)
Onderstel: eiken (massief)

Materialien

Platte: Eiche (Massiv)
Beine: Eiche (Massiv)

4 **Finishes**

**All Arco colors and finishes for
the mentioned materials**

Afwerkingen

Alle Arco kleuren en (lak)afwerkingen voor
de genoemde materialen

Ausführungen

Alle Arco Farben und Ausführungen für
die genannten Materialien

5 **Additional information**

-

Aanvullende informatie

-

Weitere Informationen

-

product

1 **Tre**2 **Standard**

Tre

		oak	transport information		
version	dimensions	solid	colli	m ³	kg
Tre	Ø55x50cm	€ 684	1	0.04	5

3 **Materials**

-

4 **Finishes**

For an overview of all current Arco colors, please refer to this price list page 5 ff or visit our website www.arco.nl.

5 **Additional information**

-

Ordering support

example

type	Tre
size	Ø55x50cm
material top	solid oak
color top	1101 - white
finish top	N-lacquer
color legs	1101 - white
finish legs	N-lacquer

1 **Utensil**Arco
Design
Studio

2012

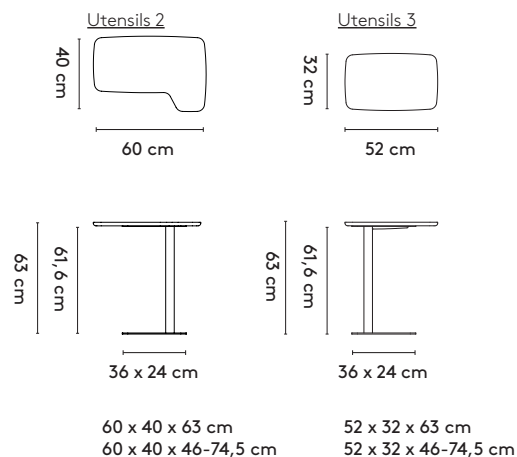
2 **Standard**3 **Materials**

Top: oak or walnut (solid)
Foot: epoxy fine texture on steel
Table sock: black

Materialen

Blad: eiken of noten (massief)
Onderstel: epoxy fine texture op staal
Sok: zwart

Materialien

Platte: Eiche oder Nussbaum (Massiv)
Untergestell: Epoxy fine texture auf Stahl
Socke: schwarz

4 **Finishes**

All Arco colors and finishes for
the mentioned materials

Afwerkingen

Alle Arco kleuren en (lak)afwerkingen voor
de genoemde materialen

Ausführungen

Alle Arco Farben und Ausführungen für
die genannten Materialien

5 **Additional information**

-

Aanvullende informatie

-

Weitere Informationen

-

product

1 Utensil

2 Standard



Utensil 2



Utensil 2 h-adjustable



Utensil 3



Utensil 3 h-adjustable

version	dimensions	oak		walnut		transport information		
		solid	solid with sock	solid	solid with sock	colli	m3	kg
Utensil 2	60x40x63cm	€ 720		€ 835		1	0.15	9
Utensil 2 h-adjustable	60x40x46-74,5cm	€ 1126	€ 1198	€ 1271	€ 1459	1	0.15	10
Utensil 3	52x32x63cm	€ 672		€ 793		1	0.10	8
Utensil 3 h-adjustable	52x32x46-74,5cm	€ 1071	€ 1126	€ 1217	€ 1410	1	0.10	10

3 Materials

-

4 Finishes

For an overview of all current Arco colors, please refer to this price list page 5 ff or visit our website www.arco.nl.

5 Additional information

Utensil 2 version left or right optional. Please indicate on your order.

Ordering support

type
size
material top
color top
material top
material frame
color frame

example

Utensil 2 right
60x40x63cm
oak
1000 - pure
oil
epoxy fine texture
5100 - RAL9010 white



Info@meinema.nl
0031 - 20 311 8396